

Oval-Master[®] Operating Manual

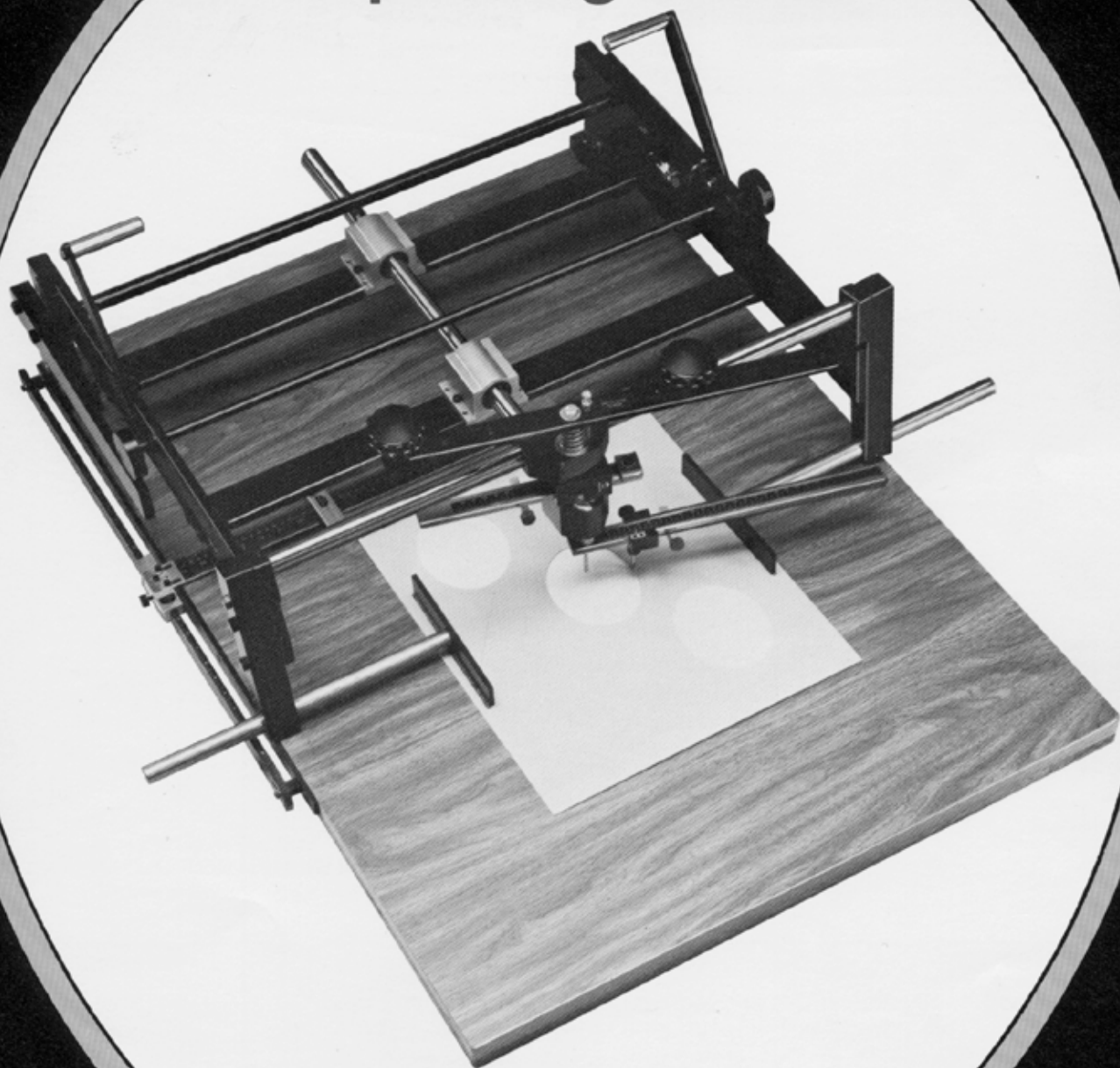

For Models 789A and 550T

Contents

	Page
Model 789A with Detachable Mat Guide	1
Jr. Model 550T with Detachable Mat Guide	2
Other Features	2
Introduction to the Oval-Master	3
Oval Mat and Glass Cutter Instructions	3
Depth Stop Screw	3
Blades	3
Cutting on a Base of Mat Boards Recommended	4
Cutting Instructions	4
Cutting Circles	4
Cutting Ovals	5
Making the Cut	5
Using Oval Mat Guide	5
Accuracy Check: A	6
Accuracy Check: B	6
Accuracy Tests for Mat Guide	7
How to Cut Circle and Oval Mats Inlay and Double	8
Cutting Mat	8
Cutting One Inlay	8
Cutting Two Inlays	8
Double Mat Oval Using Mat Guide	9
Multiple Opening Mats Using Mat Guide	9
Multiple Opening Mats — Illustrations	9, 10
How to Cut Inlay or Double Mats in Multiple Openings	10
Reverse Circle Mat	10
Inlay Photo Oval Mat	11
Contemporary Mat	12
Colored Pencil Border Lines	12
Cutting Plexiglass	12
Cutting Glass, Mirrors & Stain Glass	13
Maintenance of Machine	13
Warranty	Back Cover

Accuracy Check: A

Check for ruler accuracy by marking the center on an 8 x 10 mat board by hand, then set the oval mat guide Stop on large ruler on 4", small ruler on 5". Note screw holes are elongated in horizontal ruler and mounting bracket to adjust measurements. This will make sure ruler has been positioned correctly.

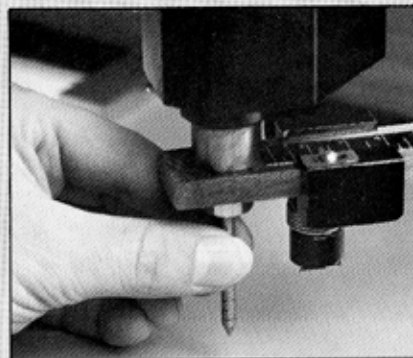

Accuracy Check: B

Also check by the following procedure: Cut and size an 11" x 14". Use bevel stem with knife blade and cut a 2" circle. Set horizontal and vertical guide at 5". With a hand held ruler, measure both dimensions, from

edge of circle to edge of mat board. This should be exact in measurements for both edges. If not, loosen the three screws at the edge of the guide and slide the guide right or left accordingly.

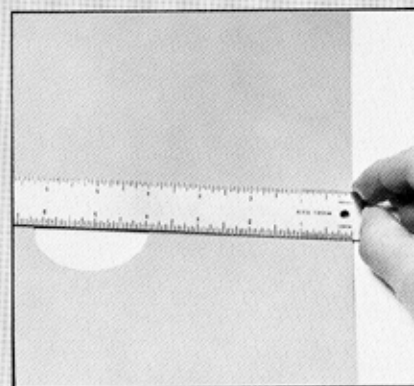
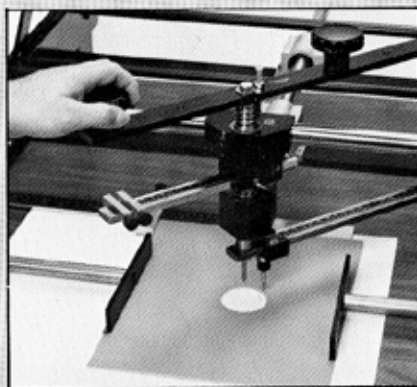

Tilting ovals are usually a result of the horizontal guide being off alignment or using the two piece bevel blade on small ovals.

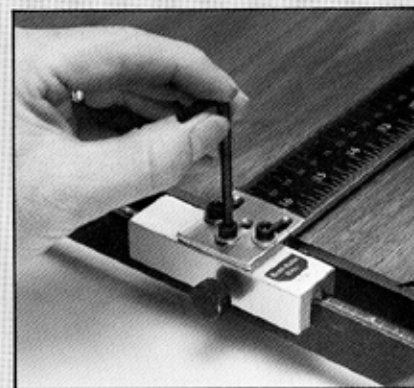

Cutting Ovals

Set lower scale (C) to width of mat. Set upper scale (D) to the difference between the width and length of the oval. Example — to cut a 5" x 8" oval — Set lower scale on 5" — set upper scale on 3"

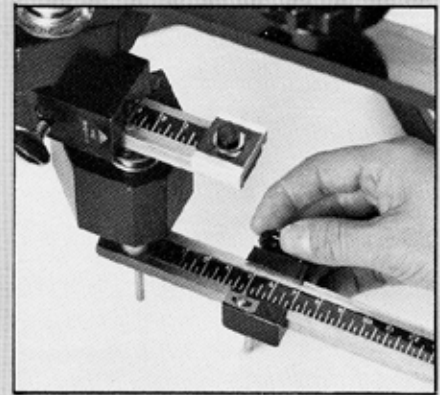

Making the Cut

On small ovals use only one hand. Place hand on knob that is above cutting head. (Large ovals will require both hands).

1. Always start your cut on the part that is to be discarded. In A, turn the blade inward before cutting. In B, tilt the blade outward before cutting. 2. Turn handle clockwise and at the same time press down on handle slightly. Note extra holes to change position in handle of knob. 3. Do not try to cut through mat in one turn. Use several turns to completely cut through. (Do not raise blade until cut is complete.) 4. Check opening size for accuracy. Note size indicator is adjustable if needed. (Due to shape of blades the opening may vary slightly.) 5. Always keep blades sharp. You can practice on a scrap mat, make a cut and carefully remove scrap mat, so that blade stays in same position. Then cut regular mat.

Note: When using bevel blades OT4 or OT5 — place mat board color side up.

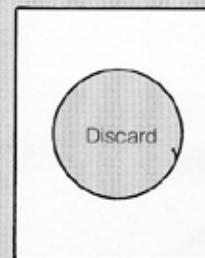
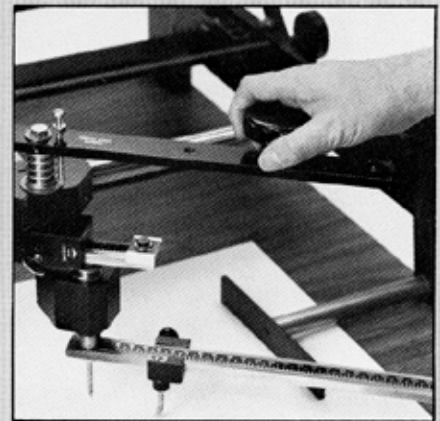

A.

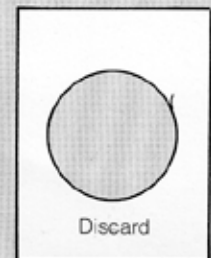

B.

When using straight blades OT6 or OT3 — you may cut mat color side up or color side down.

Cut fabric and imitation fabric with fabric side down.

Using Oval Mat Guide

We suggest you practice on a few mats, as follows: Determine outside of mat and cut to size. Set ruler stop on mat guide at $\frac{1}{2}$ the width and height of horizontal and vertical centers.

Example:

Using 8" x 10" Mat Board

Horizontal mat guide ruler (B) (large one) will be set on 4".

Vertical ruler (K) (small $\frac{1}{4}$ " one) will be set on 5".

This will put the center point (J) in the center of the mat.

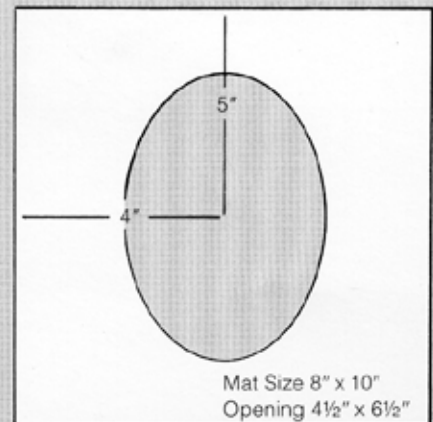

Cutting on a Base of Mat Boards is Recommended

It is recommended that you cut on mat boards, as glass will dull the blades much quicker. This machine has been leveled to cut on mat boards — just as it comes from the factory. Should you desire to cut on 1/4" Plate glass, this manual gives directions for cutting on glass.

Remember that you should have 3 (three) thicknesses of standard mat board under the hold down brackets —

- 1 - 32x40 mat taped to the base
- 1 - slip sheet mat
- 1 - mat (you are cutting)

Cutting Instructions

Make sure the mat is centered in place with the horizontal and vertical mat guides. For example, an 8" x 10" mat centered would read 5" on the vertical guide K and 4" on the horizontal guide B. Place mat

against the horizontal guide at the stop as the photo shows. Lower the cutting assembly by handle F. Note: The hold down bars should rest on the edges of the mat to keep the mat from slipping during cutting.

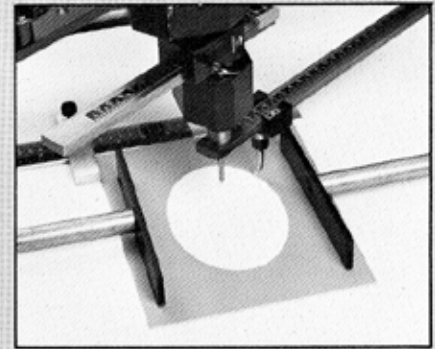
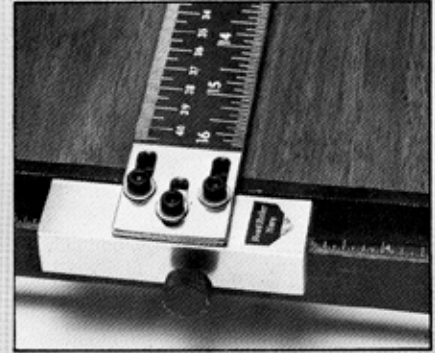
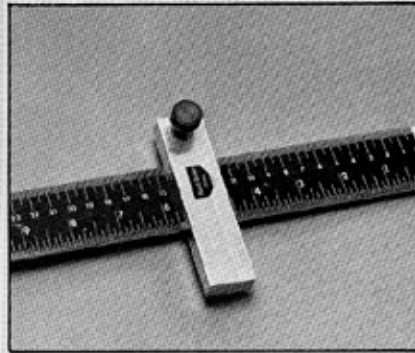

Cutting Circles

Set upper scale (D) at "O" position. Set lower scale (C) on circle size. Example — to cut a

6" circle set the top scale on "O" and the lower scale on 6".

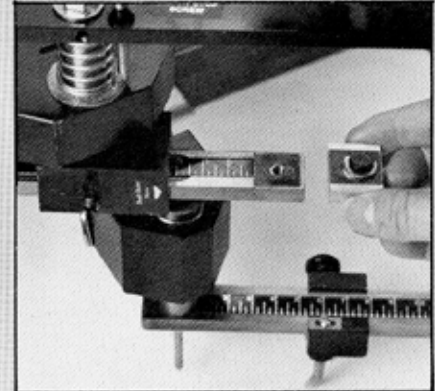
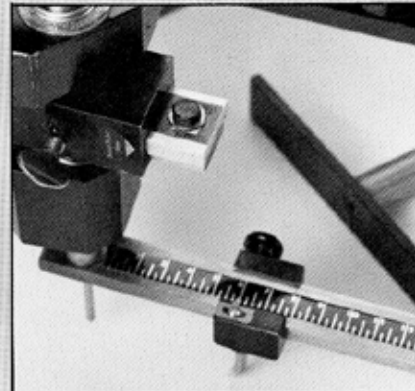

Introduction to the Oval-Master®

Oval Mat and Glass Cutter Instructions

The initial set-up of your Oval-Master is very important. Take a little time to understand your oval cutter. Oval-Master is a precision built cutter with a heavy metal frame carefully machined and assembled to

Your cutter is fully assembled and factory adjusted for use. Simply place cutter on a flat work surface. It has been shipped with handle in down position. Raise handle and insert screw inside handle as a stop to hold handle in upright position.

last a long time. It has been built for custom and production mat cutting.

The table that you place your cutter on should be flat and level. It will be difficult to align properly on uneven surfaces.

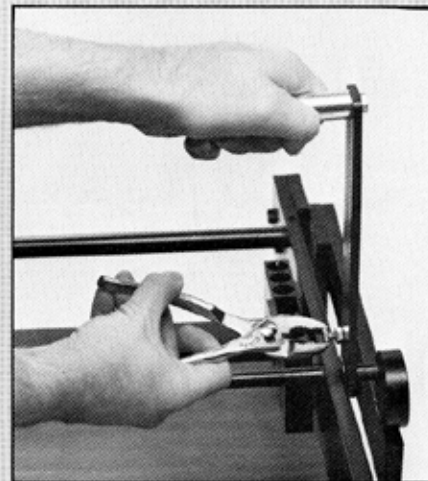

Depth Stop Screw

The depth finder screw allows for precise depth setting. It can be set to cut through just one sheet of board or to any desired depth. It is repeatable and will not change until the screw is loosened and rotated up or down.

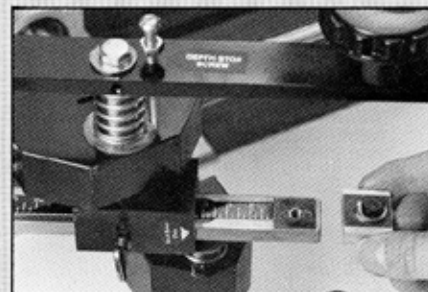

Blades

Your Oval-Master 789A will come with the following tools: Stub Knife Bevel Cut (OT4), Stub Knife Straight Cut (OT3), Bevel Stem with Knife Blade (OT5), Straight Stem with Knife Blade (OT6), Glass Cutter Stem, Complete (OT9). Determine the knife blade to be used. On large ovals use the two-piece blade. The bevel two-piece blade will also give the smallest circle. On small ovals, less than 5" x 7", use the one-piece blade.

It is best to take the tool holder off when inserting the tool. Replace it when the machine is in down position. This prevents breaking of the blade when lowering handles.

Note: The settings used on scale C for OT5 and OT6 will vary. The bevel blade will cut a

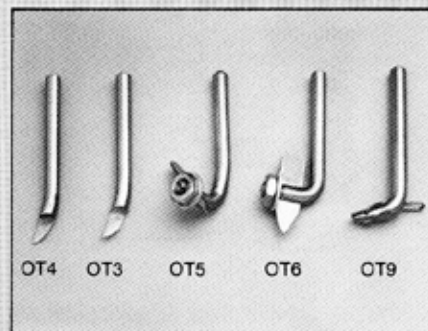

smaller opening size than the straight blade.

Note: The tool holder that fits on scale C has a brass indicator that can be adjusted for any slight variances in measurement. Adjust it for the blade that you will use the most.

Note: The Oval-Master Jr. does not include straight blades OT4 or OT6.

**Oval-Master®
Junior 550-T
With Detachable
Mat Guide**

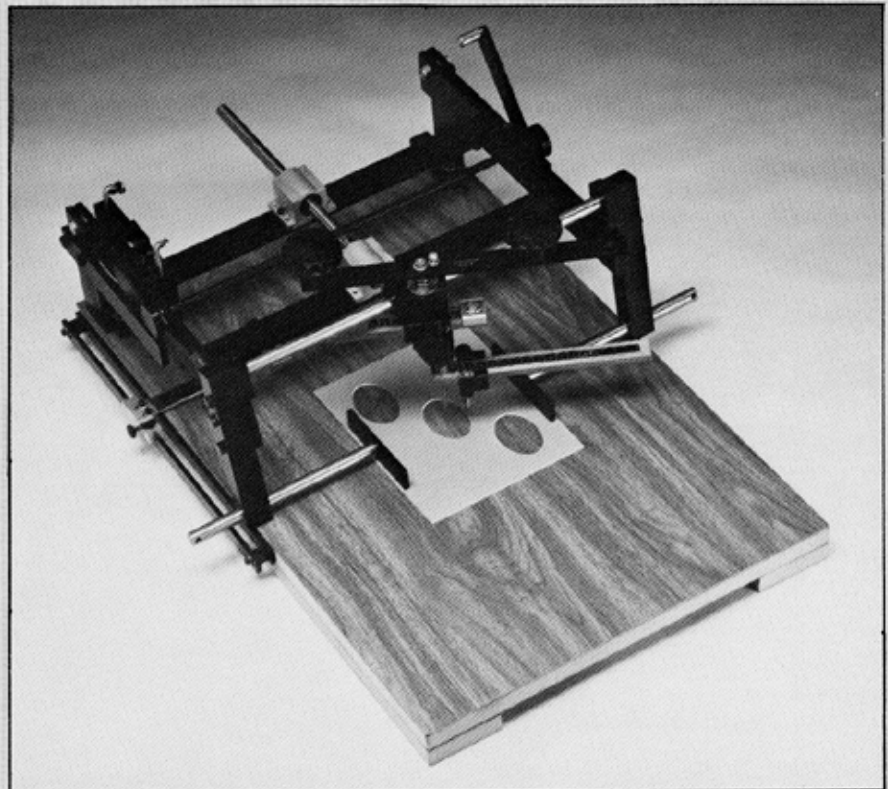

A complete miniature of Model 789A (Page 1). It requires less shop space 20" width x 31½" length. Cuts ovals 1¼" x 1½", up to 17" x 23" and circles ¾" up to 17". Comes with stub

bevel OT3 blade, bevel stem with knife blade OT5, and glass cutter tool — mounted on 1⅛" strong precision board. Also includes tool caddy (cutting edge not exposed).

Available Parts

ORS 99 Oval Ruler Stops. Repeats for production, all metal.

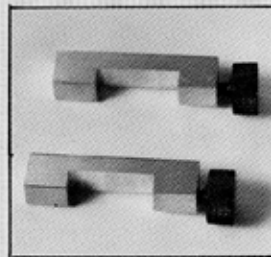

OT 11 Embossing Tool for the finished look on mats. Fits into the Oval tool holder.

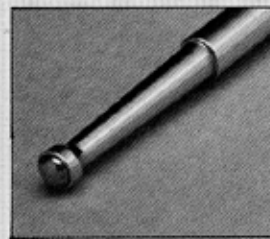

OBK 199 Oval Tool Kit contains blade OT3, OT4, OT5, OT6, OT9.

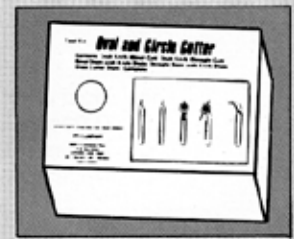

OTC 101 Tool Caddy for Oval-Master protects the blades from damage, easy storage and access.

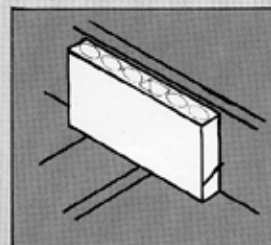

OBSK 100 Knife Blade Sharpening Kit. Reuse old blades and sharpen them like new.



Cutting Glass, Mirrors & Stain Glass

Put glass tool into holder. Apply pressure on handle until glass cutter contacts glass. Hold pressure and turn slowly to score glass. Use both hands on knobs. **A.** Score glass only once, and note that hold down brackets don't have to be on edge of glass. **B.** After scoring

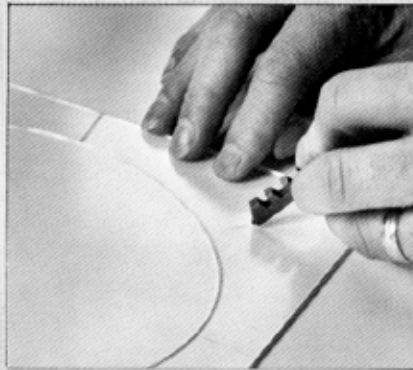
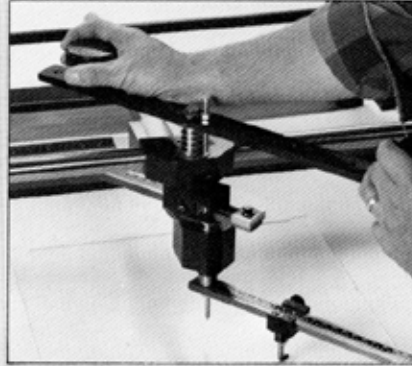

glass, turn score side down. Press score line all around. **C.** Using hand glass cutter cut score lines out to edge of glass. Start cut $\frac{1}{8}$ " from oval. **D.** After scoring lines out to edge, turn score side down and press lines. This will break glass.

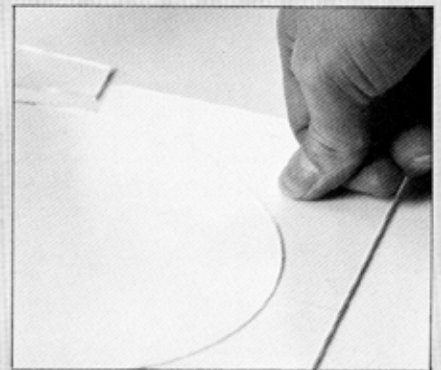
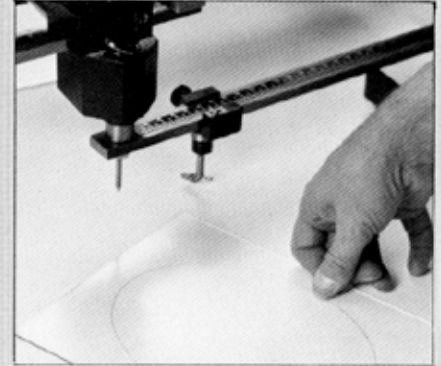

New Level Lock in Feature

Both new models 550T and 789A have this new feature. **NOTE:** The machines are preset at the factory, leveled with precision equipment and locked in. They should not need any adjustments. Please check your table to make sure it is flat and level. It may be

necessary to slip a piece of (8 x 10) mat under the cutter board on the table to assure proper cutting. (Example: Should blade cut light on left front, place mat under edge of board to raise board slightly, making it level.)

Maintenance of Machine

Make sure the table you use for oval cutter is FLAT. Use lightweight oil on all moving

parts. Oil any unpainted metal areas regularly to keep it from rusting.

Contemporary Mat

Mat size 11" x 14"

Mat Face Up

Using Bevel Stem with Blade

1. Set Oval Guide 5½" x 7". Cut 8" circle with Oval-Master.
2. Set Oval Guide 5½" x 3½". Cut 4" circle.

Turn mat around.

Cut 4" circle.

3. **Using C&H Mat Cutter**
Mat Face Down.
Set stops and mat Guide on 2½".
Cut mat on four sides.

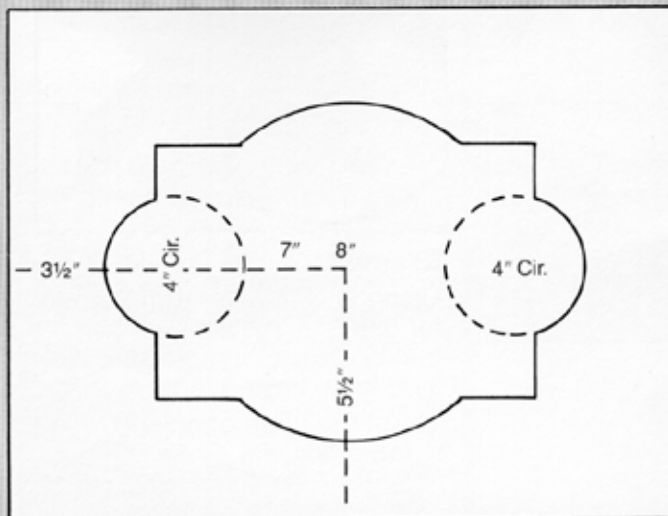

Colored Pencil Border Lines Using Oval-Master (OMP 149) Pencil Holder

The Oval-Master pencil holder is designed to fit on scale C of the Oval-Master cutter. A variety of accenting border lines and colors may be added to circular and oval mats. It has a linear French mat appeal with none of the extra troubles. Simply cut

the regular opening size, remove the blade & holder and place the pencil holder on desired width. Draw the line(s) by making several light rotations, as you would for making a cut. Keep pencil sharp.

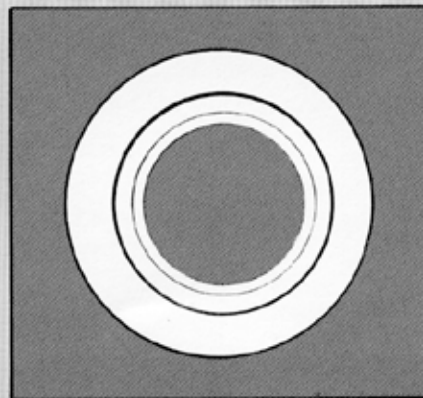
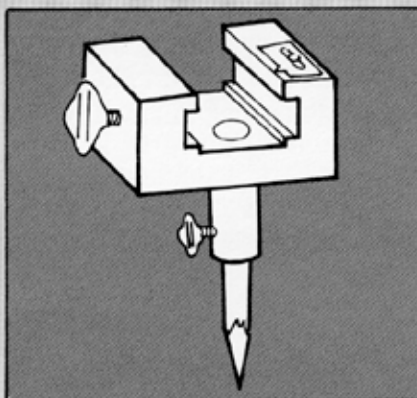

Cutting Plexiglass

Use Plastic Scoring Tool to score plastic at least 6-8 times, then break out. Plastic, dampened with water, will result in a cleaner cut.

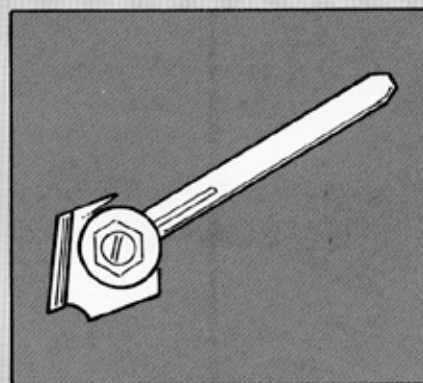

Inlay Photo Oval Mat

This mat works particularly well on grouping school photos and shots of a similar nature.

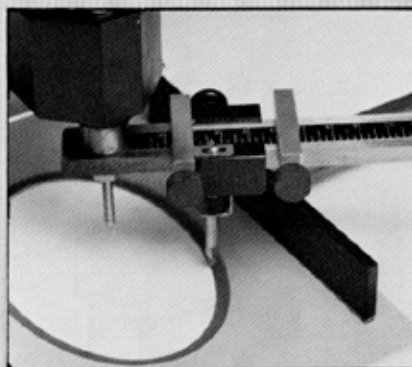

Example:

Using Oval-Master with Stops for one 8" x 10" cut from two mat boards. Cut face up with stub knife bevel blade.

1. Cut the large opening (A) in top color mat. Set a scale $\frac{1}{4}$ " larger (use stops) and cut the inlay.
2. Save all fallout. (Fig. 2)
3. Exchange the centers (inlay piece and fallout, too) and tape in place. (Fig. 3)
4. With a scrap sheet in the same inlay color, cut each oval and inlay for ovals B, C, and D. Use the stops for each $\frac{1}{4}$ " larger inlay to be cut (Fig. 4). Cut B, then B inlay, and proceed to C and D.
5. In top color mat, cut oval B at horizontal and vertical centers and the same last inlay setting (Fig. 1)
6. Change the centers and cut C at the same inlay scale setting. Again change centers and cut D at the same inlay scale setting.
7. Remove inlay pieces from scrap sheet (Fig. 4) and insert in top color mat. This completes the cutting. Tape inlay pieces securely on the back, trimming tape with razor where needed.

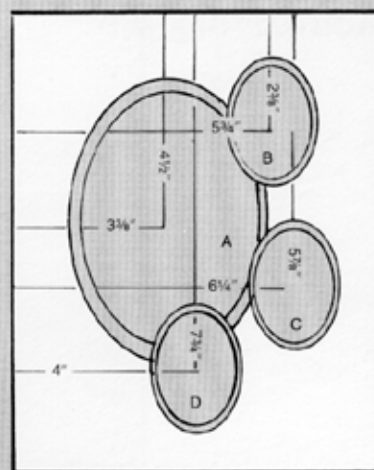

Fig. A

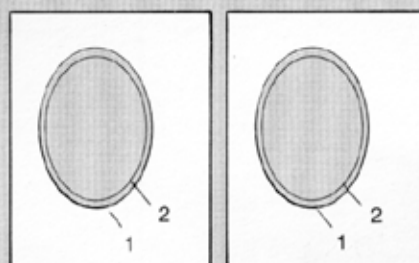

Fig. 2

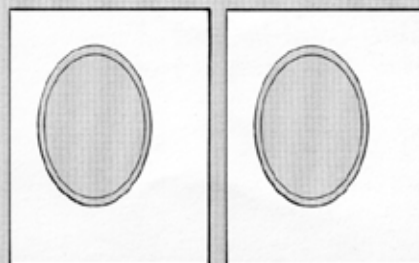

Fig. 3

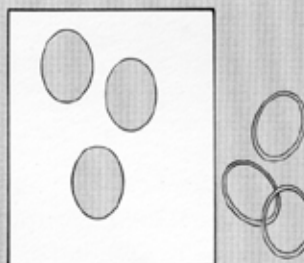
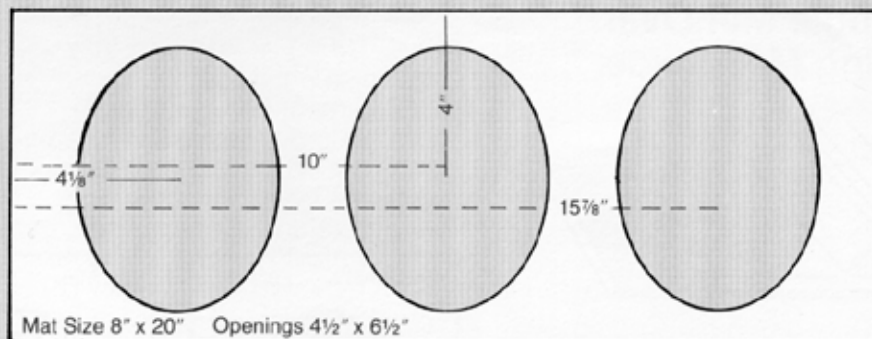

Fig. 4

Multiple Opening Mats Using Mat Guide



How to Cut Inlay or Double Mats in Multiple Openings

Set ruler on desired opening. Now attach **Ruler Stop** on left of tool holder and make cut. 2. Move tool holder $\frac{1}{4}$ " or desired inlay size. Attach second **Ruler Stop** on right of

Note: Do not use 2 piece blade for cutting small ovals, as they will be leaning. Use one piece blade on ovals measuring smaller than 5" x 7".

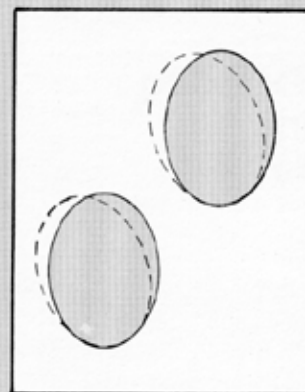
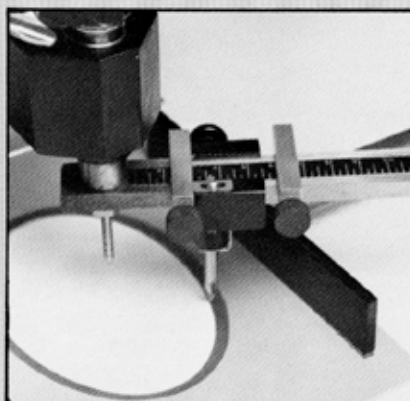

tool holder. This will allow you to cut as many inlays as you need, by moving the tool holder back and forth to make the exact same cut each time.

Tips: Cut small circles for coins from the back side. The 2 piece straight blade gives the smallest size circle possible.

Reverse Circle Mat

Example: (Use 2, 11" x 14" mat boards)

1. Using **C & H Mat Cutter** any model, cut both mats face down, set stops & mat guide on $2\frac{1}{4}$ ", cut all four sides and save fallout.
2. V-groove fallout from one mat, tape back in place.
3. Using Oval-Master, use bevel stem with knife blade. Set vertical & horizontal ruler stops at $2\frac{1}{4}$ ".

Set width (bottom ruler) at $1\frac{1}{4}$ ". Set height (top ruler) at zero. Place V-grooved mat face down.

Cut full circle.

Rotate around to cut all four.

Remove pie shaped pieces, tape to corners of other mat.

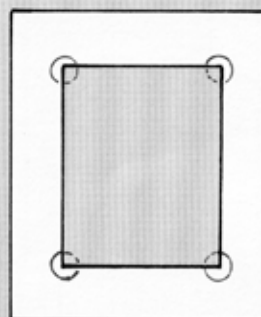

Sketch 1

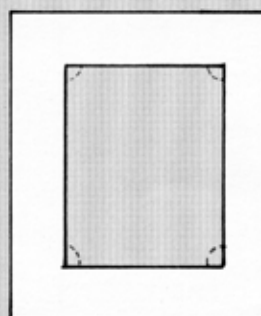

Sketch 2

Double Mat Oval Using Mat Guide

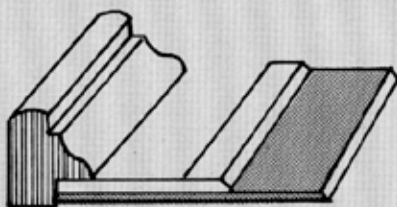

Small ovals use bevel or straight one piece blades only. Determine outside measurement of the mat and width of border needed. Mark a pencil dot on the top edge of both mats (to align mats together after cuts).

Example: 8" x 10" mat

1. Cut opening $4\frac{1}{2}$ " x $6\frac{1}{2}$ " into first mat.
2. Cut opening 5" x 7" into second mat.
3. Using "Scotch" Brand No. 924 ATG. Tape, adhere together after cuts.

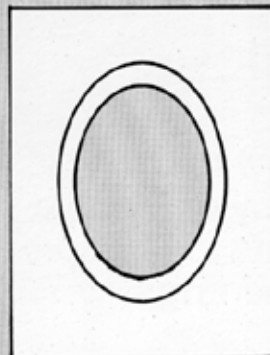
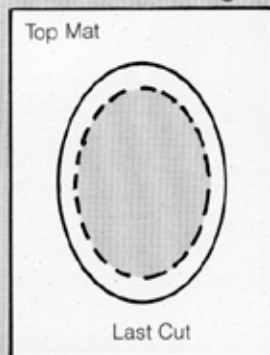
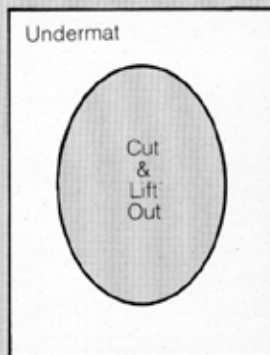

Multiple Opening Mats Using Mat Guide

Layouts for several standard sizes are indicated on these next pages.

When making different ones keep a record of them and you

will find it saves time later.

To cut the following mats, simply set ruler stops on mat guide to the horizontal and vertical centers as shown.

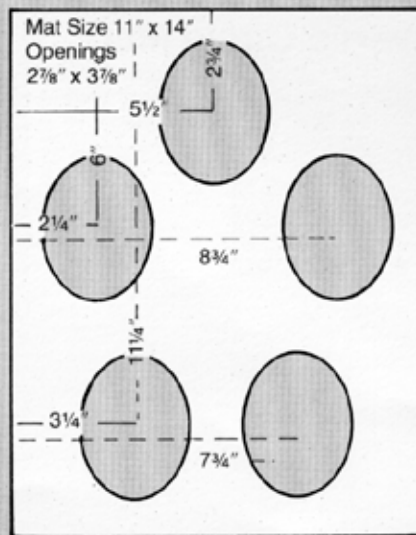
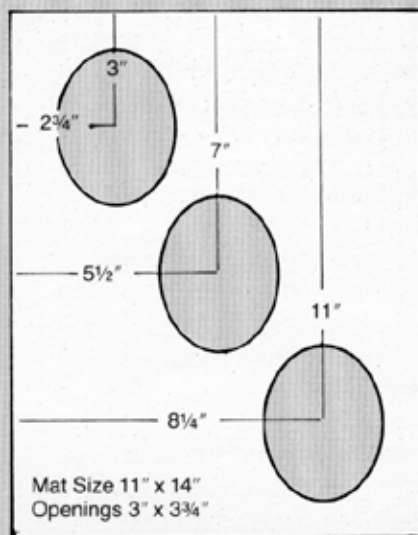
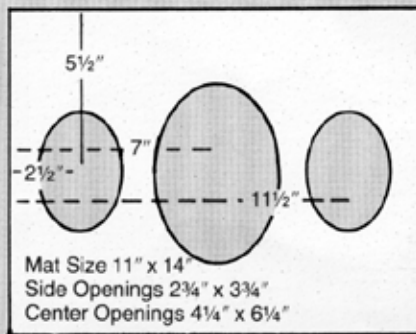
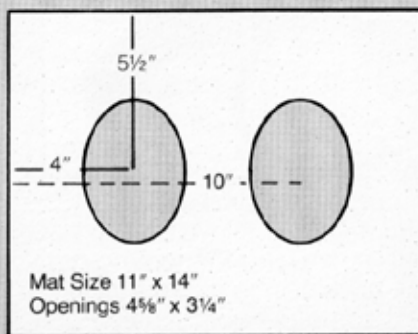

How to Cut Circle and Oval Mats Inlay and Double

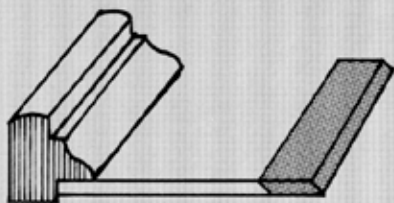

Mat and One Inlay

The oval mat guide makes inlay mats easy and accurate. Set ruler stops on mat guide at

Cutting Mat

Example:

1. Using an 8" x 10" mat board: the horizontal ruler (B) will be set on 4". The vertical ruler (K) will be set on 5".
2. Set cutter scale at opening size (4½" x 6½") and place mat against the ruler stop and guide ruler bar. (Scale C at 4½" and scale D at 2".)
3. Lower the handles and make sure that the hold down brackets clear the ruler stop on the mat guide. They should rest on the two sides of the mat.
4. Check clearance of the cutting head making sure it does not bump into the brackets.

horizontal and vertical centers. For mats smaller than 5" x 7" use the one piece stub blades.

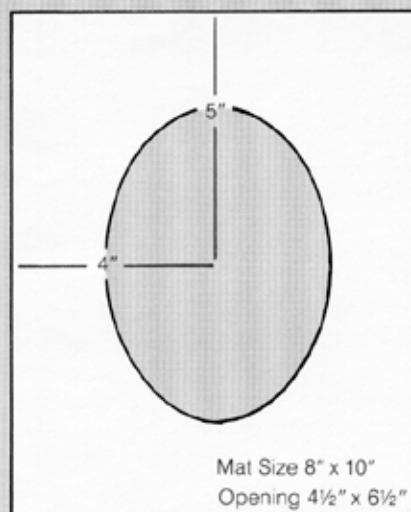

5. Cut mat — do not try to cut through in one stroke but make two or three passes or rotations until the mat is cut. Bear down more with each rotation.

Cutting Inlay Mats

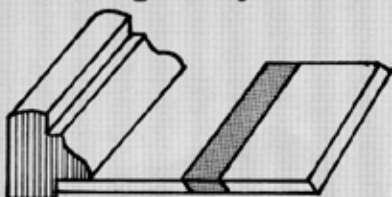

Mat and Two Inlays

1. Color used for the inlay is cut first to the desired opening (Ex: An 8" x 10" set at 4½" x 6½". Tilt blade inward.)
2. Move cutting head away from center to desired width of inlay (5" instead of 4½"). Tilt blade outward).

3. In this position make second cut (which makes the inlay). Remove mat and inlay piece.
4. With cutting head in same position, place mat to be used for the outside main color into position and cut.
5. Turn pieces over and tape in place.

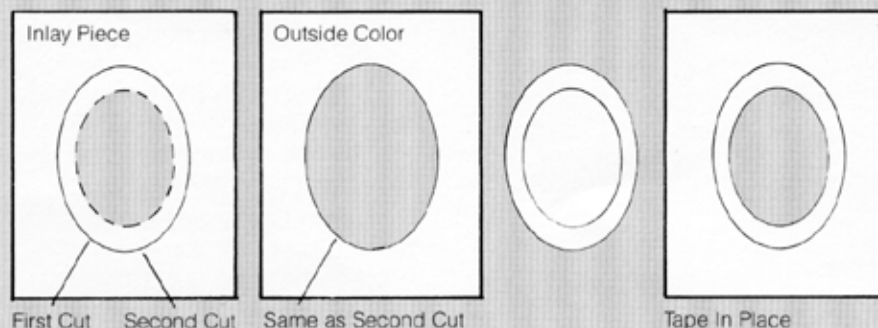

Cutting Two Inlays

For a mat with two inlays follow above directions for cutting inlays — Numbers 1, 2, 3, 4. While in Step No. 4, move cutting head away from center

to desired width of inlay. In this position make second cut (which makes the inlay). With cutting head in same position, place outside mat and cut.

Accuracy Tests for Mat Guide

Center an 11" x 14" mat board. Make sure it is exactly an 11" x 14" and in square. Set the scales for a 2" circle. Lower the handles and the centering pin. Mark the center. With a pencil mark an x at the top edge of the board. Remove board and measure the distances from the center point to the outside edges. If the side measurements are not equal, adjustments are needed.

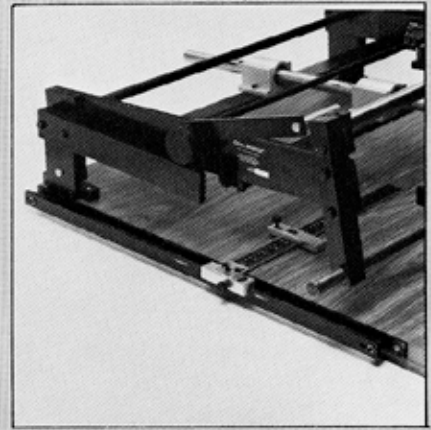

Vertical Adjustments

Let's say the centerpoint was marked here.

But actual measurement shows the correct centerpoint to be here.

The vertical mat guide screws K should be loosened and the entire guide slid up until the center point hits true center.

Tighten screws. Check again.

The board should still read the same center point when the bottom edge of the board is reversed with the top edge.

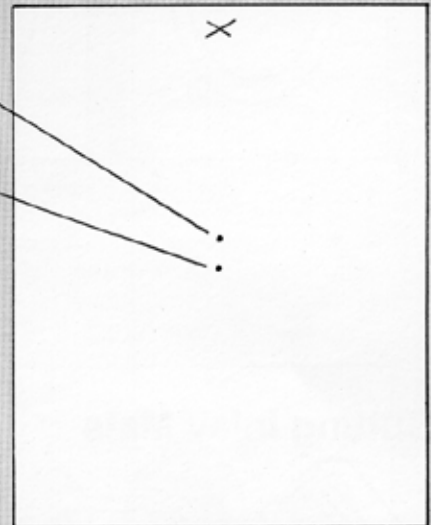

Horizontal Adjustments

Mark center as before and measure to the outside edges.

For example, true center is here, the three screws B should be loosened and the guide slid left. Be sure that the guide is squared up with the base board before tightening screws. A final check is done by scoring a two inch circle on the board.

Then turn the board around and the score should be the same in placement horizontally and vertically.

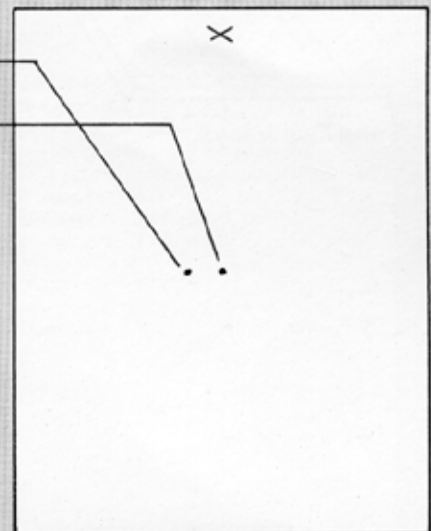

Model OMC 789A With Detachable Mat Guide

This model cuts glass, mats, mirrors and plastic; cuts multiple openings with speed and accuracy; and, accurately repeats itself for production. It has been leveled at the factory with precision equipment, and the level locked in. It requires a shop space of 32" width x 45" length. Cuts ovals 1½" up to 28" x 40", circles ¾" up to 28". Features Depth Adjustment; Mat Guide and Centering Pin

for automatic centering; Case Hard Polished Rod and Rolling Bearing Assembly; and Automatic Circle Stop. Comes complete with OT9 Glass Cutter, OT3 Stub Knife (Bevel Cut), OT4 Stub Knife (Straight Cut), OT5 Bevel Stem with Knife Blade and OT6 Straight Stem with Knife Blade. Also includes tool caddy (cutting edge not exposed).

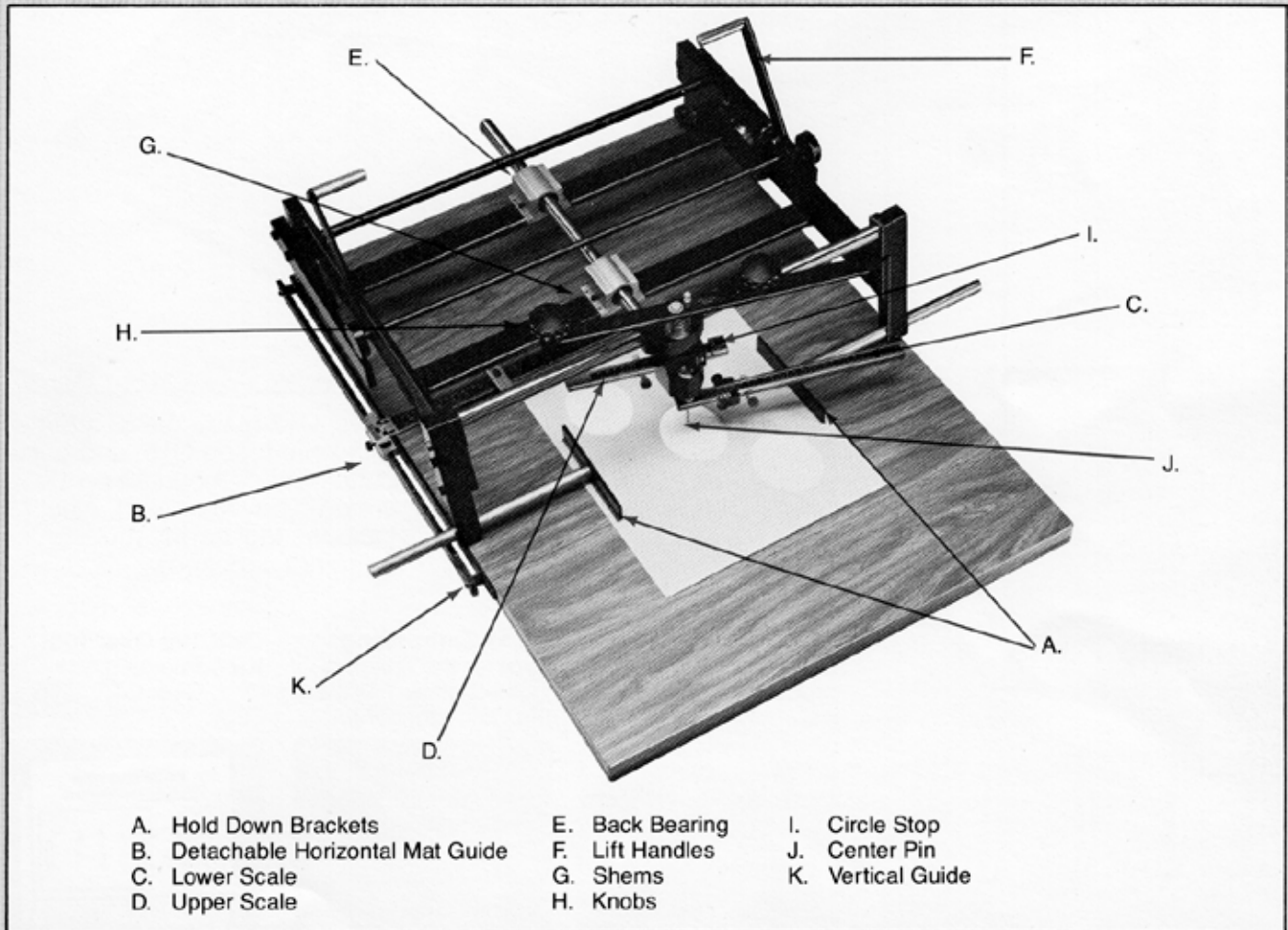

Oval Mat Guide OMG 100

This eliminates having to draw lines on the base of cutter; also

eliminates use of T-Square to line up work.

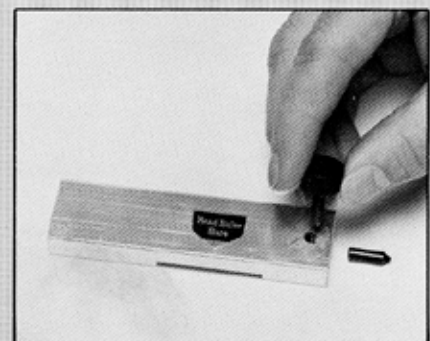
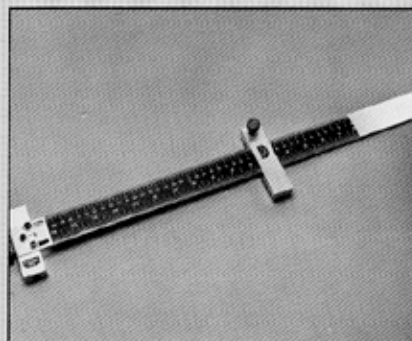

WARRANTY

We warrant each new C & H Cutter to be free from defects in material and workmanship for a period of ninety (90) days after original purchase, under normal use and service. Each machine will be thoroughly inspected by us before shipment to be sure it is in perfect condition. We agree to repair or replace any such defective unit or replace such parts, at our discretion, provided the defective unit or parts are returned to us intact, transportation prepaid, within the warranty period, and that our examination discloses to our satisfaction that the unit is defective. Proof of purchase must be submitted by you to validate this warranty coverage.

This Warranty shall not apply to any cutter or part thereof which has been repaired or altered in any way, or which has been subject to misuse, negligence, or accident.

This Warranty is in lieu of all other warranties expressed or implied including the warranties of merchantability and fitness for use, and the manufacturer neither assumes nor authorizes any representative or other person to assume for it, any other liability in connection with the sale, maintenance, or repair of said cutter. In no event shall C & H Manufacturing be liable for any damages or losses, incidental or consequential, direct or indirect, arising out of the use of this product.

C & H Manufacturing, whose policy is one of continued product improvements, reserves the right to make changes in design and construction at any time without incurring any obligation on cutters previously manufactured.