

Description of Models

CHN 4060 — Up to 40" Cut

CHN 4800 — Up to 48" Cut

CHN 6000 — Up to 60" Cut

A-Models — Complete with Mat Guide and Squaring Arm

B-Models — Includes Mat Guide, no Squaring Arm

Optional Accessories

CH60 Measuring Stops

CH125 Multi-Angle Plates

CH20 Reverse Bevel Mat Guide

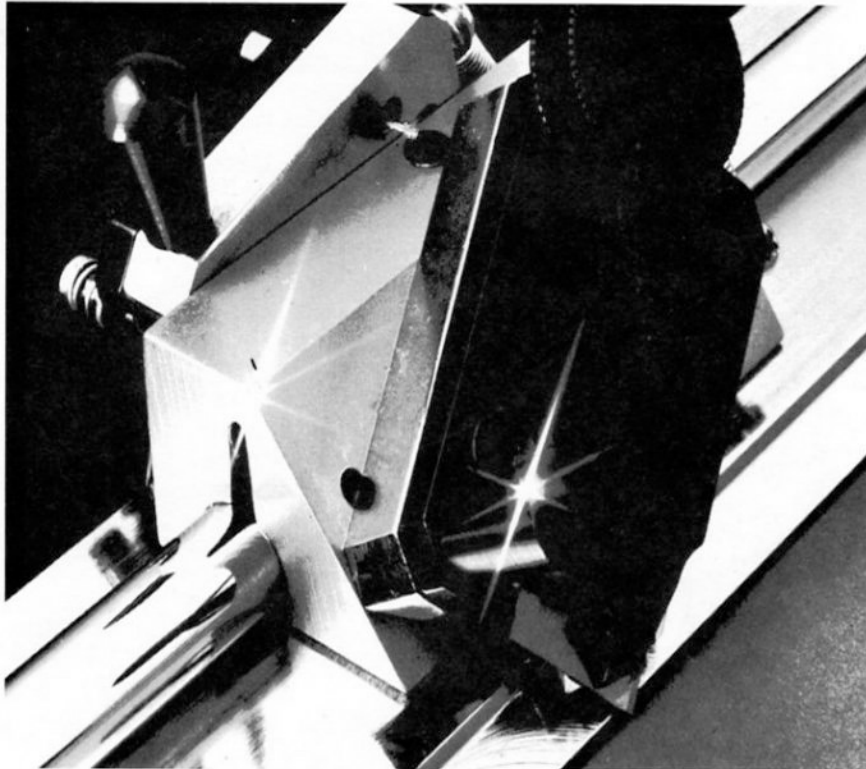
Note: Cutters packed for overseas shipment are assembled with metric rulers in place of the English rulers shown in illustrations.

Contents	1
Description of Cutter Parts	2
Unpacking and Assembly Instructions	3
Calibrating Your Cutter	3
Cleaning and Lubricating	4
Blades and Blade Adjustments	4
Table Surface	5
Basic Cutting Techniques	5
Cutting a Single-Opening Mat Without Stops	6
Cutting a Single-Opening Mat with CH60 Stops	6
Adjusting CH60 Stops	7
Adjusting C&H Cutting Block	7
Attachments — Using the CH125 Multi-Angle Plate Kit	8
Attachments — Using the CH20 Reverse Bevel Mat Guide	8
How to Cut Double Mats	9
How to Cut Mats with Unequal Borders	10
How to Cut Offset Corner Mats	10
How to Set Your V-Groove Stop	10
How to Cut V-Groove Mats	11
How to Cut Inlay Mats	11
How to Cut 3D Double-Bevel Mats	12
How to Cut Slant (Photo) Corner Mats	12
How to Cut Fabric-Covered Board and Wrap Edges	13
Trouble Shooting Guide	14
C&H Mat Cutters Parts List	16
CH60 Detachable Measuring Stops Parts List	17
C&H Head Assembly Parts List	18
Warranty — Service, Parts and Repair Sources	20

Contents

Your C&H Mat Cutter is a precision instrument and is constructed of durable, high quality components. With the proper care and maintenance it will provide you with years of satisfactory performance. Familiarize yourself with the function and the features of the following list of cutter parts called out in Fig. 1:

1. Bar and Rod Assembly — These two components are precision ground, chrome plated steel. They are fastened together with a deliberate bow in the middle. This provides uniform pressure on the bar when pressure is applied to the handle. The rod and bar also provide the tracking surface for the sliding block.

2. Baseboard — 1" (25.4 mm) thick, resin-impregnated fibreboard provides a sturdy, warp-resistant base for cutting.

3. Bearing Blocks — These are spacers in the offset hinges which hold the bar and rod assembly, and also allow it to pivot.

4. Bevel Blade Holder — An adjustable assembly which is mounted and pivots on the left side of the sliding block. Designed for C&H No. 1200 and 1500 blades.

5. Bottom Measuring Stop (Optional) — This is one component of the CH60 measuring stops. It is an adjustable control for the end of the cutting stroke.

6. Handle — Fastened at each end to the offset hinges. Pressure on this handle provides the clamping force on the bar and rod assembly to keep the board being cut from slipping.

7. Offset Hinges — Support the bar and rod assembly. Spring action allows good clamping pressure on mat being cut.

8. Mat Guide — Controls the width of the mat being cut. It has a clamping screw on both ends and is adjustable to assure parallel edges.

9. Mat Guide Adjustment Screw — Allows adjustment of the mat guide bar to assure parallel mat width.

10. Mat Guide Clamping Screws — For securing the mat guide.

11. Mat Guide Top Plate — The bottom clamping surface for the mat guide. Contains the bottom mat guide ruler and V-groove stop.

12. Slide Block — A highly precision-machined, adjustable block which rides on the bar and rod assembly. Both blade holders are fastened to this block.

13. Squaring Arm (A-Models only) — This adjustable aluminum arm is used for positioning boards when cutting to size with the straight blade holder.

14. Squaring Arm Stop — An adjustable stop for repetitive sizing of boards.

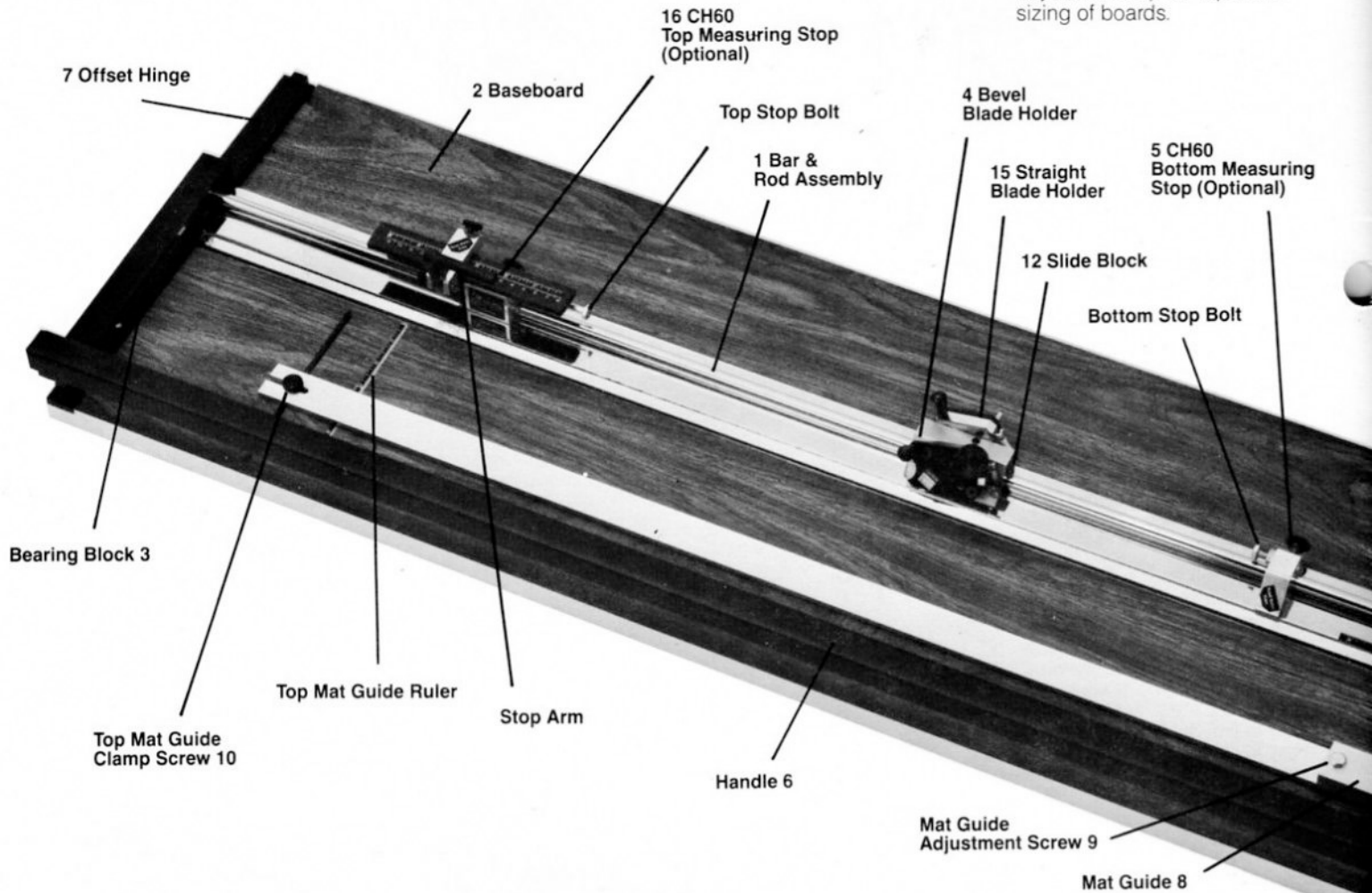

Description of Cutter Parts

15. Straight Side Blade Holder — An assembly which is mounted and pivots on the right side of the slide block. Designed for "Stanley" No. 1991 blade or equivalent. Used for squaring and cutting boards to size.

16. Top Measuring Stop (Optional) — The second component of the CH60 measuring stops. It is an adjustable control for the start of the cutting stroke.

17. V-Groove Stop — An adjustable cam button located on the mat guide top plate, which is used to set the position of the mat guide for cutting V-groove mats.

13 Squaring Arm (A-Models Only)

14 Squaring Arm Stop

7 Offset Hinge

3 Bearing Block

V-Groove Stop 17

Mat Guide Top Plate 11

Bottom Mat Guide Clamp Screw 10

Unpacking and Assembly Instructions

Check your mat cutter for any visible signs of damage. If the package is damaged, examine the adjacent portion of the mat cutter with special care. Report any damage to the shipper immediately.

Carton contents:

Besides the mat cutter, the carton should contain:

- Attached mat guide
- Squaring arm (A-models only)
- Operating manual (includes trouble-shooting guide and parts list)
 - Warranty card and inspector's statement
- Parts envelope which includes:
 - 10 — No. 1200 blades
 - 10 — No. 1500 blades
 - 5 — Stanley No. 1991 blades or equivalent
 - 1 — Squaring arm stop (A-models only)
 - 1 — Knurled screw — 10-24x1/2"-5/8" dia. head (A-models only)
 - 3 — Allen wrenches — 3/32", 1/8", 5/32" (5/32" with A-models only)
- Test mat
- Letter

Assembly:

Remove squaring arm (if so equipped) from taped position under handle and attach to mat cutter using 5/8" dia. knurled screw. Make sure cam lug on bottom of arm fits into corresponding hole in baseboard.

Safety Precautions: This machine is equipped with two sharp blades which are not fully exposed, but which do require some caution. Keep hands away from the protruding blade tips and from under the bar and rod assembly, especially if the straight side cutting blade is in the locked-down position.

Calibrating Your Cutter

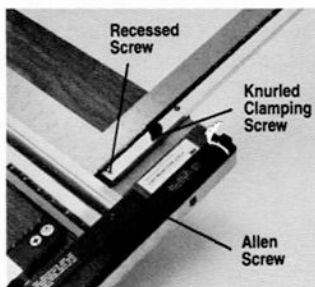

Your C&H Cutter is adjusted at the factory but must be rechecked because of possible misalignment caused by shipping. It is important to check your cutter in the following sequence:

1. After installing the squaring arm (A-Models only), take a factory-cut piece of glass or a framing square and lay it on the squaring arm against the edge of the bar and rod assembly. If this angle is not square, slightly loosen the clamping screw that holds the squaring arm down. With an allen wrench, loosen the allen screw on the outside, left end of the arm. Using a common screwdriver, turn the recessed screw on the top of the arm until the arm is square with the bar. Retighten the allen screw and the clamping screw.

2. Remove mat guide.

3. Lift the handle of the cutter and slide the glass or framing square over until it rests against the mat guide top plate. This plate should be aligned perfectly with the squaring arm. If not, loosen the two recessed screws holding the plate down and adjust it so it lines up with the squaring device. Retighten recessed screws.

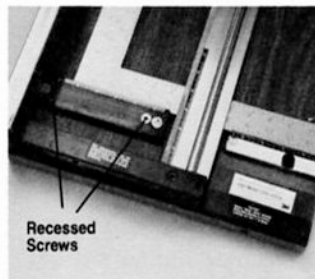

If you have a B-Model cutter without the squaring arm, adjust the mat guide plate so that it is square with the left side of the bar and rod assembly.

4. Clamp the mat guide to the mat guide top plate. Set the mat guide at 2" (50mm) on the bottom ruler and tighten both top and bottom clamping screws. Lift the handle and put a piece of squared mat board in the corner formed by the mat guide and the mat guide top plate. Lower the handle. Holding a pencil vertically, draw a short line on the board.

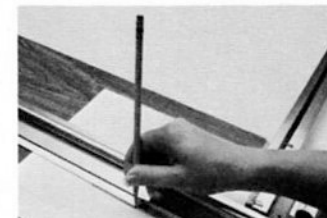

Lift the handle and move the board up against the top edge of the mat guide. Lower the handle. Again holding the pencil vertically, draw another line over the original line.

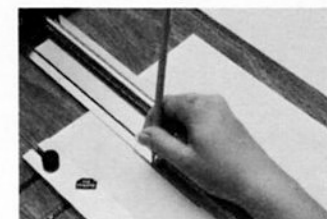

The lines should be superimposed. If not, loosen the mat guide bar adjustment screw



and the top clamping screw and adjust the bar accordingly. Tighten both screws again and repeat the mat board/pencil marking check. Readjust the bar if necessary. When aligned properly, the mat guide settings should read the same on both rulers.

Unpacking and Assembly Instructions

Calibrating Your Cutter

Cleaning and Lubricating

Your C&H cutter requires regular cleaning and lubrication for best performance and longest life. The bar and rod assembly should be cleaned with solvent regularly (lighter fluid or adhesive remover). Use a cotton swab to get into the crevice on either side of the rod and bar.

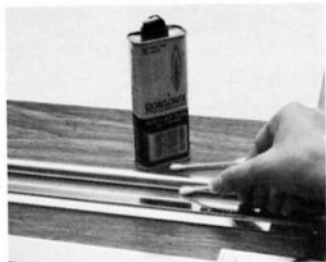

For lubrication we recommend "Super-Kote",



an aerosol, dry lubricant, available from your framing supplier. After spraying on a light coat, run the block back and forth on the bar and rod assembly several times. Let the lubricant dry and wipe off the excess. It is recommended that the slide block be removed periodically to clean the bottom bearing surfaces. **(Important! Remove both blades from the cutter first!)** Remove the two screws in the bottom bearing block.

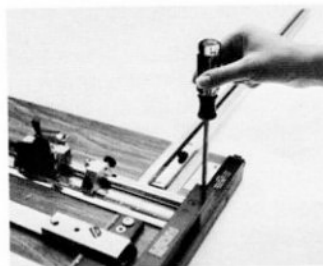

Pull the bearing block off the rod and then slide the block off. Clean the bottom surface and rod cavity with solvent,

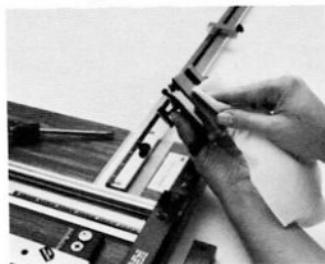

spray lightly with "Super-Kote" and reinstall on cutter.

Blades and Blade Adjustments

A sharp blade and proper adjustments will produce the best looking mats.

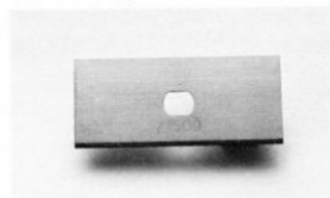

Bevel Cuts — This cutter is designed for use with our No. 1200 [.012" (0.3048 mm) thick] blades. The No. 1200 blade is recommended for regular mat board while the No. 1500 [.015" (0.381 mm) thick] cuts best on heavier or the harder, acid-free mat boards.

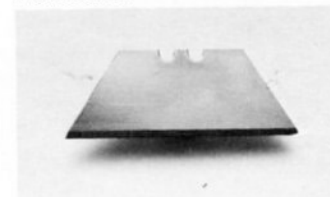

Straight Cuts — The "Stanley" No. 1991 Blade or equivalent is recommended.

Changing Blades (Bevel Cutter)

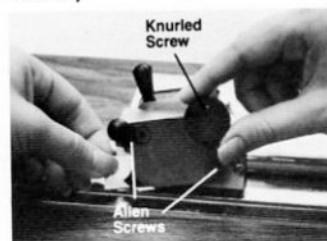

Loosen the large knurled screw on the blade holder, pull the used blade out and up. Insert the new blade into the holder with care. If not inserted properly the other end of the blade will dig into the inside of the blade holder and cause blade edge damage. Tighten knurled screw. If blade is still loose, slightly loosen allen screws on top plate and retighten knurled screw. (Do not loosen these screws too much, as blade can slip up between blade holder and plate.)

Setting Blade Depth (Bevel Cutter)

The blade should project from the blade holder so that it cuts through the board being cut and slightly scores the slip sheet underneath.



Test this out with two scrap pieces of mat board. A blade protruding too far will not have enough support, will flex and cause hooked corners.

To adjust the blade depth, loosen the large knurled screw.



While holding the blade in from the front, adjust the blade depth with the allen screw on the back of the holder. Retighten the knurled screw.

Changing Straight Side Cutting Blade

Loosen large knurled screw, push in spring-loaded blade locking button and pull blade out and up. Depress button to insert new blade. Retighten the screw. Standard mat board can be cut with the blade locked down. Simply push the blade holder down, push the locking pin over



Cleaning and Lubricating

Blades and Blade Adjustments

and release the holder. For heavier, harder mat board or mount board, two passes with the blade is recommended in the **unlocked** position.

Straight-Side Blade Holder Locking Pin Adjustment Set Screw

An adjusting set screw is located in the top of the slide block. It acts as an adjustable stop for the locking pin on the straight-side blade holder and controls the depth of cut. It is factory-set to accommodate most board thicknesses that you would cut with the blade **locked down**.



If an adjustment is necessary, use the 1/8" allen wrench included with the cutter. Simply turn the screw **in** to **reduce** the cutting depth of the blade when it is in the locked position. Turn the screw **out** to **increase** the blade depth.

Table Surface

Your cutter table should be flat. Any warping will also allow the cutter baseboard to warp and produce inconsistent cuts. Put pieces of mat board under the cutter baseboard as needed to level it.

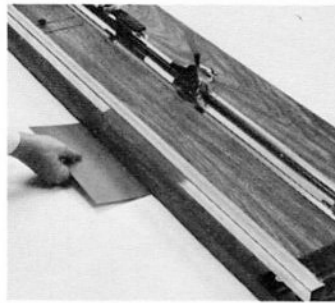

"Bumpons" can be applied to the bottom of the cutter to prevent slippage. It is important that they be placed no further than 6" apart for good support.

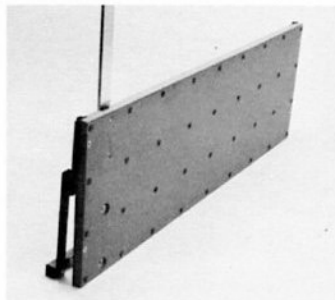

You can also fasten the cutter down on both ends. This is recommended on the Model CHN 6000A.

Basic Bevel Cutting Technique

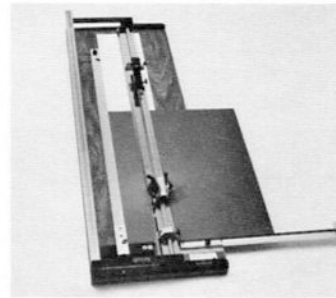

Always use a piece of mat board (not mount board) 6" wide x the capacity of the cutter as a slip sheet under the mat being cut. It will compress the board and produce a clean cut. Move the board slightly for each cut and switch ends and/or replace it if it becomes ragged.

Holding the Cutter

Stand at the end of the cutter

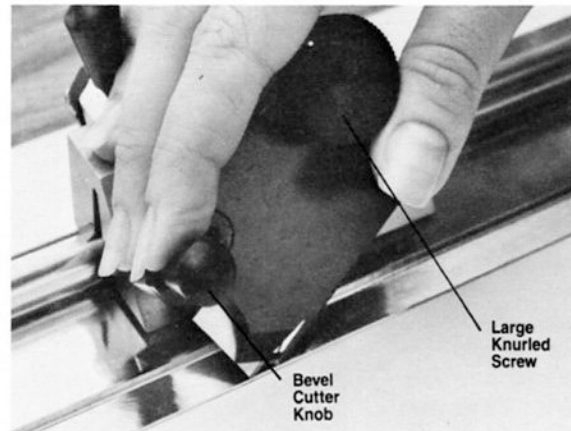

and lift the handle. Insert the mat board under the bar. The most comfortable position will be to rest the index and middle fingers on the bevel cutter knob. Place the thumb loosely under the large knurled screw as shown. Insert the blade smoothly rather than jabbing it into the board by pushing down with two fingers on the knob. Push the blade down all the way and then, using the two finger pressure only, pull back on the slide block until you reach the desired distance and then release the cutter. It is important to keep the blade fully depressed while pulling it. **Do not** apply upward pressure

with the thumb as you are pulling. This is a pivot point only and applying pressure here may bind the cutter and/or tilt the cutting block enough to produce hooked corners.

Handle Pressure

The handle should be held opposite the middle of the board being cut.

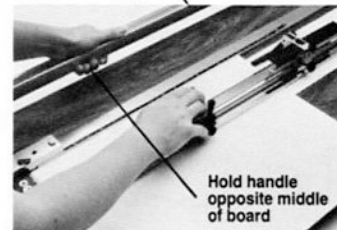

Apply pressure so that the bar flattens out. Too much pressure may cause the bar to bow up in the middle and cause uneven cuts.

Table Surface

Basic Bevel Cutting Techniques

Cutting a Single-Opening Mat without Stops

Pencil mark the back of a mat board which has been cut to size. (Hold pencil at same angle as bevel blade.) Use the mat guide

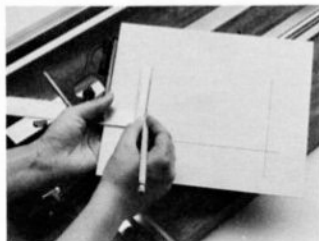
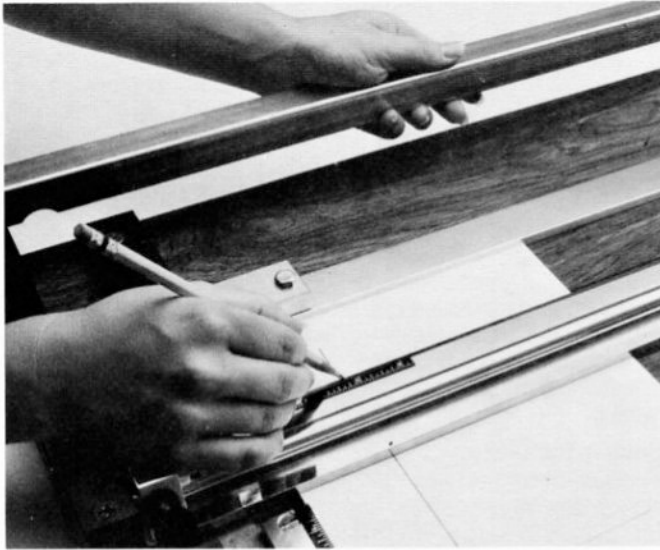

or a mat marker to produce overlapping corner lines. Set the mat guide for the desired mat width.

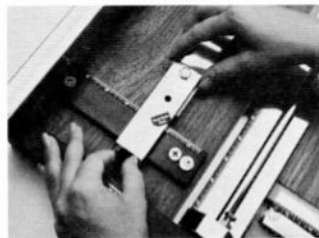

Raise the handle and place the board, colored side down, in the corner formed by the mat guide and mat guide top plate.

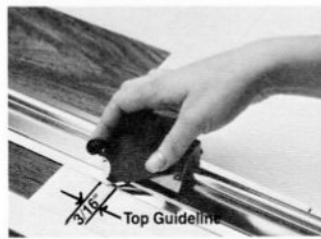

Slide the block up and depress the blade fully so it enters the board approximately 3/16" (5mm) **above** the top intersecting horizontal guide line.

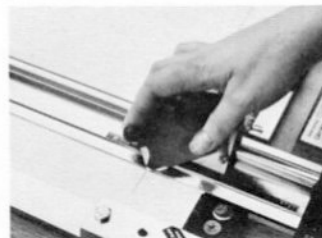
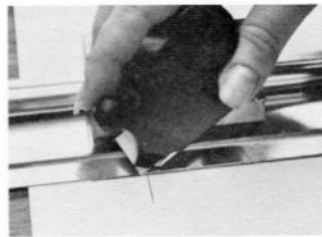

Pull the slide block until the back cutting edge of the blade is approximately 3/16" (5mm) **below** the bottom intersecting horizontal guide line.

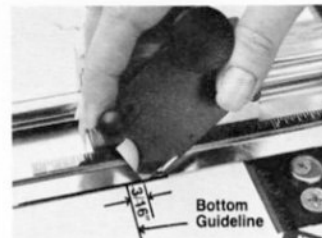

Release the blade holder. Repeat on the other three sides.

Cutting a Single-Opening Mat using the C&H CH60 Detachable Measuring Stops (Optional)

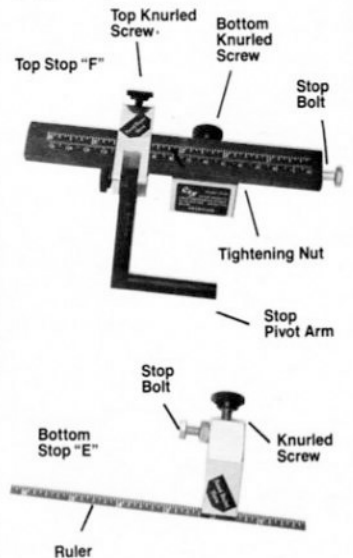

When adjusted properly, the CH60 stops allow the user to cut mats without pencil marks and visually observing the start and stop of each cut. They eliminate overcuts and undercuts, producing precision cut mats whether cutting individual mats or production volume.

(Example) Set the mat guide for 2" (50mm).



Lift the handle and place a piece of squared mat board, colored side down, in the cutter in the corner formed by the mat guide and mat guide top plate.

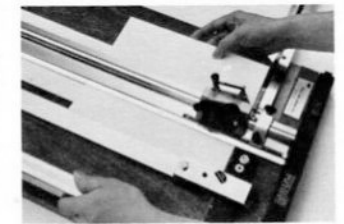

Cutting a Single-Opening Mat Without Stops

Cutting a Single-Opening Mat with CH60 Stops

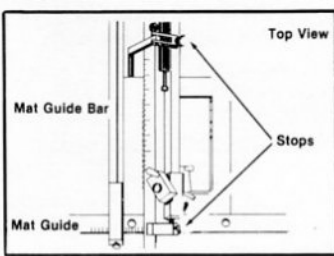

Place the stops on the rod and set the top stop at 2" (50mm) by loosening the top knurled screw

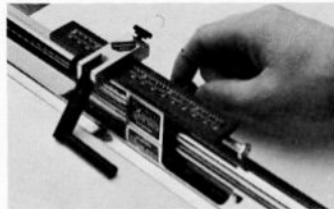

(read all stops on the side with the arrow that says "read ruler here"). Position the top stop so that the arm rests against the top edge of the board.

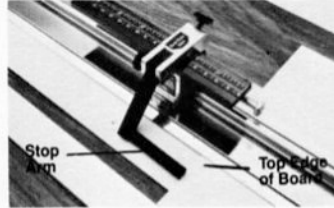

Tighten in place with large knurled screw.

Set the bottom stop at 2" (50mm) and tighten down hard with the knurled screw.



Slide the cutting block up until it touches the stop bolt.

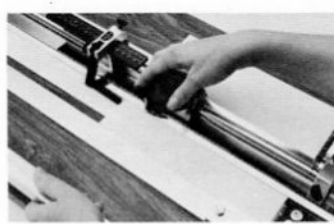

Depress the blade all the way into the mat board. Pull the slide block down until it hits the bottom stop.

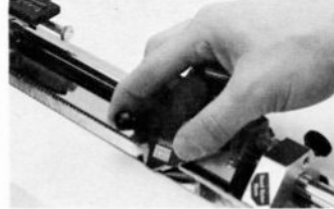

(Don't hit the stops too hard as they may move.) Release blade holder. Repeat on opposite side and then reposition top stop only for other dimension of board and cut both sides.

Adjusting CH60 Stops
Besides these adjustments, it should be noted that unsquare boards, improper blade depth and inconsistent technique can also cause cutting variables. To adjust and correct overcuts or undercuts, check each cut on the back of the board. The beginning of the cut (top stop) should start 3/16" (5mm) above the top intersecting horizontal cut. Likewise, the end of the cut (bottom stop) should stop 3/16" (5mm) below the bottom intersecting cut.

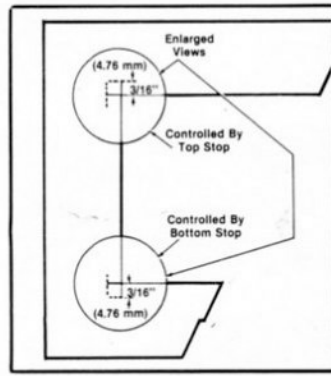

If not, adjustments are required. To correct **overcuts** on the top stop, loosen the nut on the stop bolt



and screw the bolt out (toward the mat). To correct **undercuts** screw the bolt in (away from the mat). The bottom stop can be adjusted the same way.

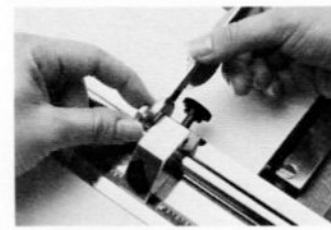

Tighten nuts after adjustment.

Adjusting C&H Cutting Block
Note: The block on your new cutter has been adjusted at the factory and should not require further calibration before use.
1. If adjustments are necessary, use the two recessed allen screws

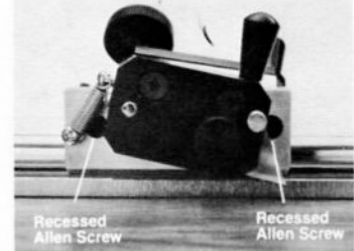

on the straight cutter side of the block. Before adjusting, remove the block from the bar/rod and clean and lubricate inside the block cavity and the bar/rod (see Cleaning and Lubricating section).

2. Reinstall block and slide back and forth to find tightest spot on bar/rod. Adjust the block in this area.

3. Adjust one screw at a time. Screw it in until the block won't move. Then back the screw out slightly, until the block slides smoothly the whole length of the bar/rod. Repeat procedure on the other screw.

Adjusting CH60 Stops

Adjusting C&H Cutting Block

Using the CH125 Multi-Angle Plate Kit (Optional)

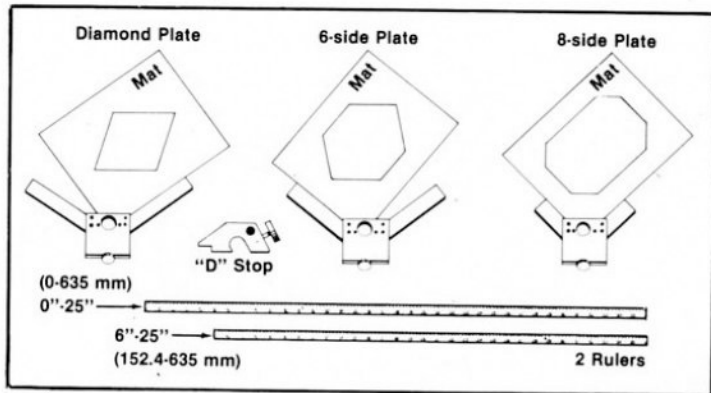

Designed to fit all C&H cutters and to be used with bottom CH60 stop. A fast, accurate, easy way to cut multi-angle mats, with precise corners every time. All-metal.

CH125 Kit Includes:

Diamond Plate
6-Side Plate
8-Side Plate
"D" Stop
2 Rulers

Installation Instructions:

With a clean cloth and lighter fluid, clean the length of the left hand side of the cutter bar and the mat guide.



Slide the cutting head to the top. Remove stops. Remove factory-installed 6" (152mm) ruler from bar. Remove release paper from the back of the 0"-

25" (0-635mm) ruler. Align ruler along the left edge of the bar, starting 3/8" (9mm) up from the bearing block.



Press in place.

Loosen the clamping screw on the mat guide. Slide guide right until it stops. Tighten the screw. Align the other ruler to match bar ruler and apply as before. Press rulers down firmly when in position.

Position of ruler, stops and plates are shown.

Stop settings obviously will vary for each size and type of mat.

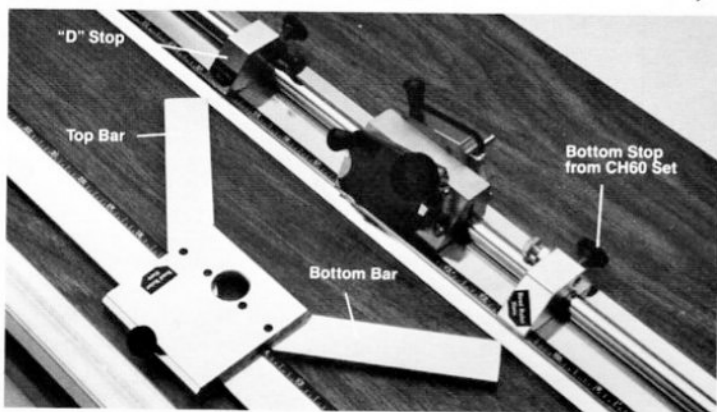

Instructions for Using the CH125 Multi-Angle Plate Kit

We recommend laying out each mat by pencil, using the mat guide and the desired plate, before cutting. As an example: in cutting an 8-sided mat with 2" (50mm) borders,

set the mat guide for 2" (50mm) and draw pencil guide lines on the four sides. Use the 8-sided plate to pencil in the position of the corner cuts. Next, cut the four parallel sides, overlapping the corner guide lines by 3/16" (5mm). Then, using the plate to position the board, make the corner cuts, making sure you overcut each side guide line by 3/16" (5mm). If doing production cuts, determine the mat guide setting and stop setting to create the desired corner. Set the guide and stops accordingly. Mat size and type of corner will affect settings. Limitations of the 6" (152mm) mat guide width restricts the use of these plates to mats no larger than 12" x 16" (304 x 406mm) and on standard sizes of mat board up to this size.

Basic Hints in Positioning Mat Board During Cutting

Diamond Mats

First pair of parallel cuts — place **long** side of board against **top** bar of plate.
Second pair of parallel cuts — place **long** side of board against **bottom** bar of plate.

6-Sided Mats

First make side cuts using mat guide. Second pair of parallel cuts — place **short** side of board against **top** bar of plate.
Third pair of parallel cuts — place **short** side of board against **bottom** bar of plate.

8-Sided Mats

Mat fits squarely into plate corner — no difference in position. Simply alternate corners.

Using the CH20 Reverse Bevel Mat Guide (Optional)

Fast, accurate way to cut reverse bevels easily. Model CH20 with 6" (152mm) ruler is easy to attach to cutter, quick to remove.

Designed for all C&H Straight Line Mat Cutters, shown with Model CHN 4060A.

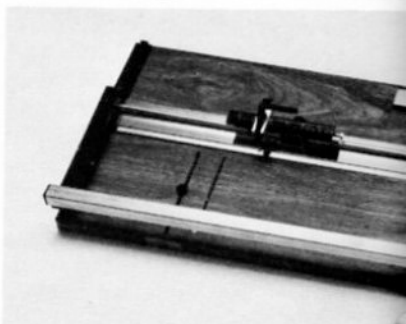
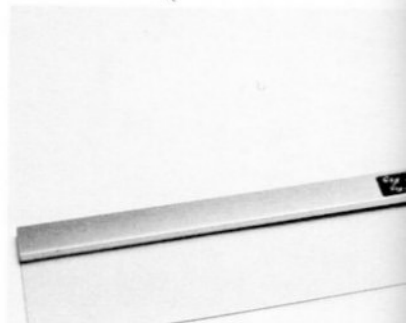

Installation Instructions:

1. Mount mat guide top plate in squaring arm slot with recessed screw and allen wrench provided.
2. Remove protective liner and apply ruler to top plate. Position flush in top left corner. Ruler should read from left to right.
3. Adjust mat guide bar so left edge of plastic is parallel with right edge of bar.

Instructions For Use:

Remove standard CH36 Mat Guide from cutter. Use cutter and stops as you would in cutting regular mat openings only insert the board color side down under cutting bar and against plastic edge of guide. Adjust guide for desired mat width.

Attachments — Using the CH125 Multi-Angle Plate Kit

Attachments — Using the CH20 Reverse Bevel Mat Guide

How to Cut Double Mats (Using the Mat Guide & CH60 Measuring Stops)

Tape Required: Scotch® brand 924 Adhesive Transfer Tape.

Dispenser Required: Scotch® brand 752 ATG Dispenser.

1. Determine outside measurement of the mat and width of border needed.
2. Trim the mat used for the lip (or under mat). (Trim $\frac{1}{4}$ " (6.35 mm) off short and long side.)
3. Set guide & stops and cut top mat (color side down) and save the fallout inside section.
4. Apply Scotch® brand No. 924 ATG tape to all four sides on the back of the top mat.

5. Adhere the mats together with front of back mat against back of front mat. Back mat should **not** protrude over edge of front mat.

6. Place small ATG tape strip on back side of top mat fallout.
7. Place mat fallout back into position.
8. Apply pressure by rolling across surface.
9. Set mat guide and stops the desired size of lip. Cut color face down.

NOTE: For triple or additional multiples repeat steps 4 through 10 for each mat.

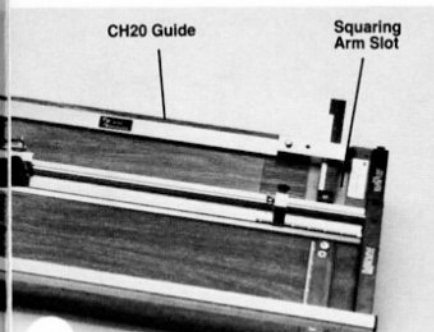
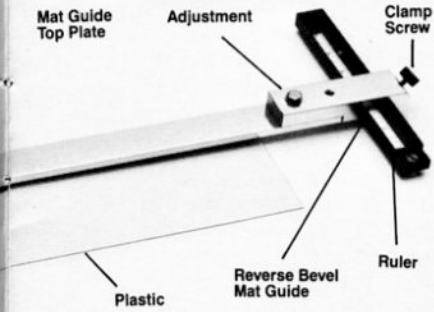

CH20 Kit Includes:
Mat Guide with Adjustable Bar
Mat Guide Top Plate
Ruler

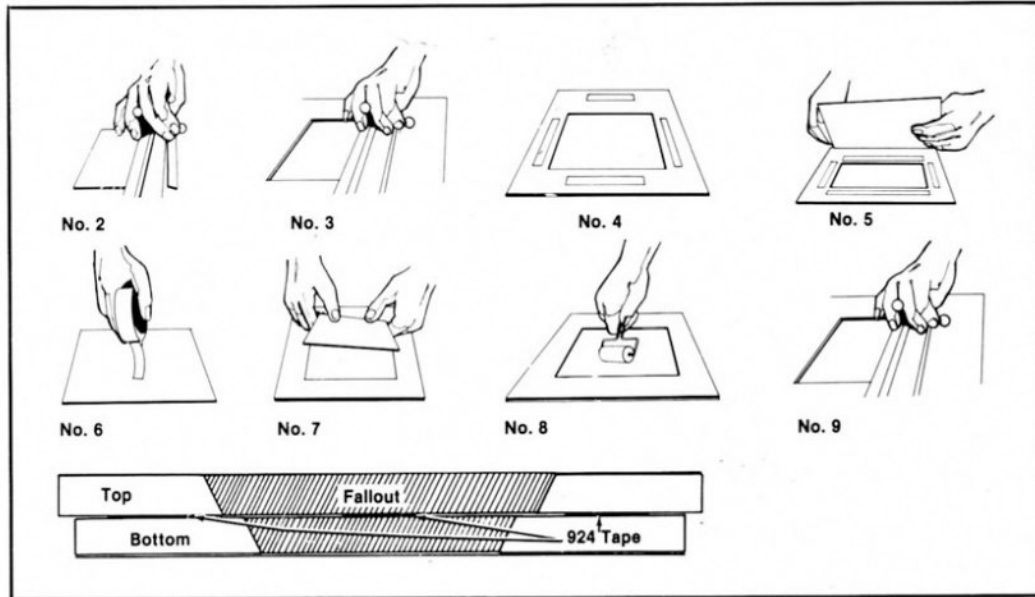

How to Cut Double Mats

How to Cut Mats with Unequal Borders

Use detachable stops and mat guide. Example: When a 2½" (63.5 mm) border is desired on one side of the mat. There are two ways of doing this: (example is for 8" x 10").

Procedure One:

1. Set guide at 2½" (63.5 mm) and stops at 2" (50.8 mm). Mark an x on mat edge near guide. Cut length.
2. Move mat clockwise so x is at top. Set guide at 2". Top stop at 2½". Make one cut.
3. Move mat clockwise so x is at right. Set stops and guide at 2". Cut short side.
4. Move mat so 2½" and x are on bottom towards you in cutter. Set bottom stop at 2½". Set guide and top stop at 2".

Procedure Two:

1. Cut the mat with equal borders (2½").
2. Trim off 3 sides to create one unequal border.

How to Cut Offset Corner Mats (Using the Mat Guide and CH60 Measuring Stops)

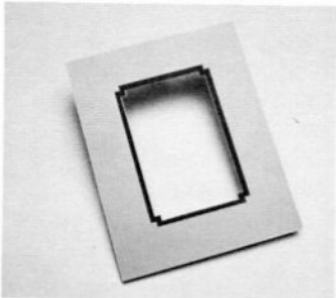

Example Settings for 8" x 10" 203 x 254mm) Mat

First Set of Cuts: Place mat face down, set guide at 2" (50 mm), stops at 2¼" (57 mm). Cut all four sides. NOTE: Mat will not fall apart.

Second Set of Cuts: Place mat face down, set guide at 2¼" (57 mm) and stops at 2" (50 mm). Do not make full length cuts. Make 1" (25 mm) long cuts in top and bottom corners on all 4 sides.

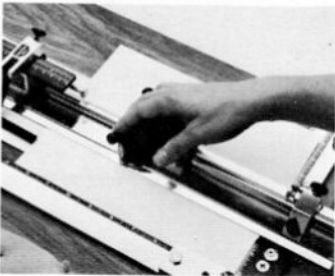

To Cut a Double Offset Corner

1. Adhere front mat cut at left together with back mat board which has been trimmed to be slightly smaller than front mat, using Scotch® brand 924 Tape. (Colored side of back mat against back of front mat.)
2. Adhere fallout piece in place with short strip of 924 tape.
3. Set mat guide at 2¼" (57 mm) with stops at 2½" (63 mm). Cut all four sides with mat colored side down.
4. Reset mat guide at 2½" (63 mm), stops at 2¼" (57 mm). Repeat 1" (25 mm) long corner cuts on all four sides as in single offset corner mat.

How to Set Your V-Groove Stop

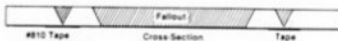
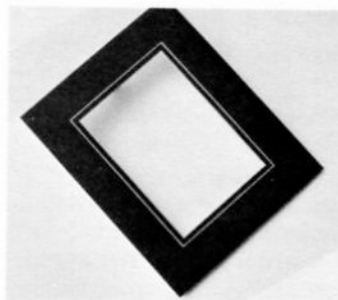

Procedure for setting the V-groove Stop.

This stop is built into the mat guide assembly for easy adjustment. It gives you precise control of V-groove widths and allows you to accurately repeat the same setting. The mat guide bar has a milled slot

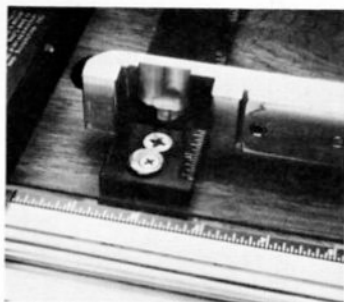

in the bottom. The V-groove stop rides in this slot and adjustment of the stop will control the distance between the mat guide and the cutter bar. This distance should be approximately ⅛" (3mm). To adjust the stop, loosen the recessed screw and rotate the stop slightly in either direction

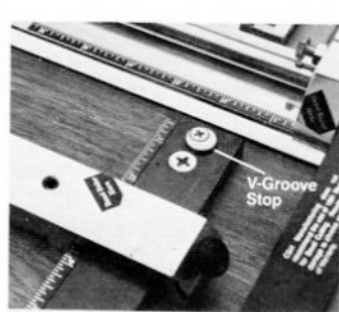

Tighten the screw. This will adjust the guide either left or right. Cut a mat and readjust if necessary for desired V-groove width.

NOTE: Cutting too much off the bevel will not allow the mat pieces to fit precisely together. Also, mat guide must be parallel with bar/rod to trim off equal edges. See page 5 for adjustment.

How to Cut Mats with Unequal Borders

How to Cut Offset Corner Mats

How to Set Your V-Groove Stop

How to Cut a V-Groove Mat

Tape Required: Scotch® brand 810 Magic Transparent Tape — ¾" or 1" x 72 yards (19 or 25mm x 65.8m).

Dispenser Required: Scotch® brand C-25 or P-54W Dispensers.

1. Pencil mark the back of the board to later match pieces together.

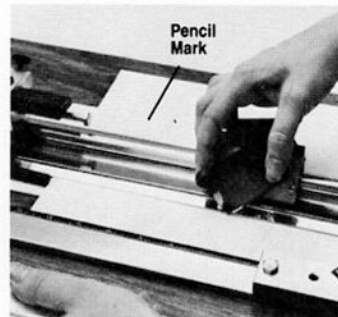

Set mat guide and stops and cut desired opening in mat board, colored side down.

2. Remove slip sheet from under cutting bar, move stops out of the way and move mat guide all the way to the right. Insert fallout piece in cutter against mat guide, **colored side up**. Trim off bevel on each side.

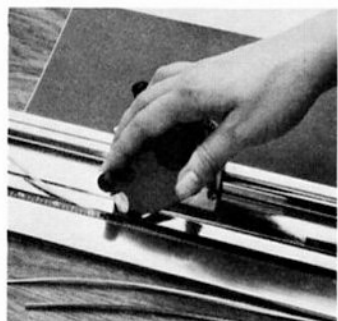

3. Apply Scotch® brand 810 Tape to two sides of the back of the mat so it extends into the opening about ¼" (6mm). Do not extend the tape further than the anticipated width of the V-groove inlay.

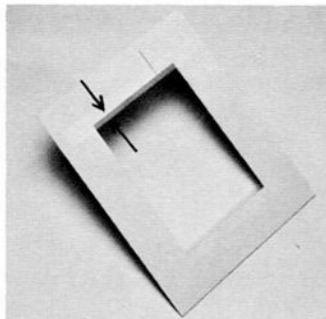

4. Turn the mat over and position the fallout in the mat opening.

Be sure to line up the pencil marks on the back of the mat. Tape the remaining two sides with Scotch® brand 810 Tape.

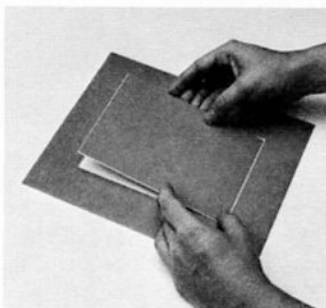

5. Readjust mat guide and stops for mat opening and cut all four sides.

NOTE: to add additional V-grooves, repeat steps 1 through 4.

How to Cut an Inlay Mat

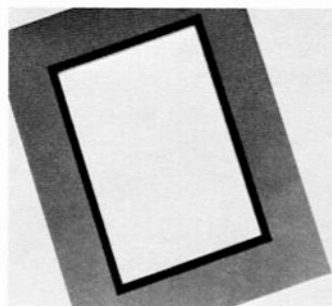

Tapes Required: Scotch® brand 924 Adhesive Transfer Tape and Scotch® brand 810 Magic Transparent Tape.

Dispensers Required: Scotch® brand 752 ATG Dispenser and Scotch® brand C-25 or P-54W Dispenser.

Inlaid mats fit together like a puzzle. Two or more rectangles fit inside one another, like a double or triple outline around the art. The surface is flat and the whole creation is just the thickness of one mat board.

Contrasting colors and contrasting widths add to the interest.

You can use as many colors as you wish in inlays and thereby simulate the depth of multiple mats. However, since the whole inlay creation is only a single thickness, it will not cause the same fuzziness under nonglare glass as a true multiple mat. You may use several colors and

have the results of a French Mat without the time and skill of the real thing.

1. Select two mat boards.
2. Cut ¼" (6mm) from 2 opposing edges of the inlay board.
3. Apply Scotch® brand 924 Tape in 1" (25mm) long strips to four outside edges.
4. Adhere mats together with front of inlay mat against back of outside mat. Make sure inlay mat board does not protrude beyond edge of outside mat.
5. Set mat guide and stops and cut desired opening in inlay mat [example: 2" (50mm)]. Mat will not fall apart yet.
6. Reset mat guide for outside of inlay [example: 1¼" (44mm)]. Move stops out of the way and cut all four sides from top to bottom. Make sure blade is not set too deep.
7. Twist and remove outside pieces. Rub off Scotch® brand 924 Tape from back of mat.
8. Mark inlay piece and outside mat before separating inlay piece. Discard fallout.
9. Without changing mat guide setting, cut opening for inlay in outside mat.
10. Lay inlay piece face down and position outside mat over it, matching up pencil marks. Tape together with Scotch® brand 810 Tape and roll down.

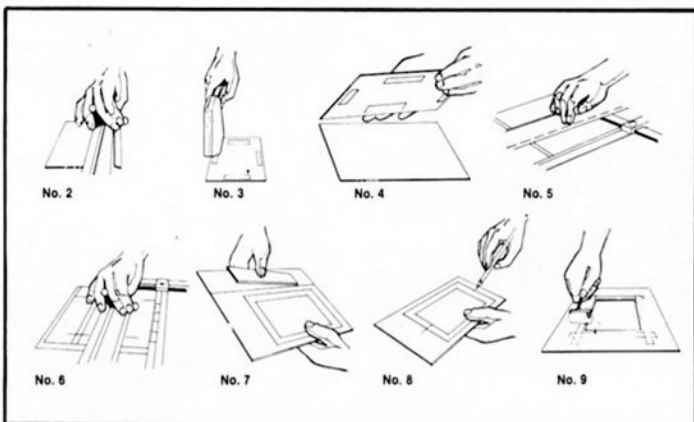

How to Cut V-Groove Mats

How to Cut Inlay Mats

How to Cut a 3D Double-Bevel Mat

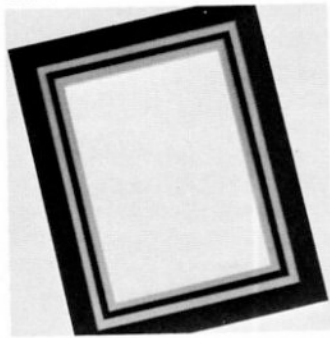

Adhesive Required: Scotch® brand 568 Positionable Mounting Adhesive.

Dispensers Required: Scotch® brand T-639 Squeegee or C-35 PMA Applicator and C-36 Dispensing Tray.

Example: 8" x 10" (203 x 254mm) Mat

1. Select 2 pieces of mat board and cut to same size. Apply 568 PMA to back of top mat. Trim to size and **leave liner on**.

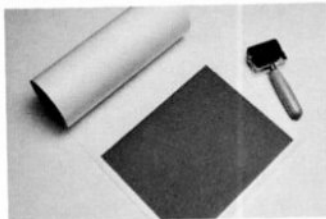

2. Set mat guide and stops for opening in bottom mat [example: 2¼" (57mm)]. Cut mat opening, colored side down. Discard fallout and set bottom mat aside.

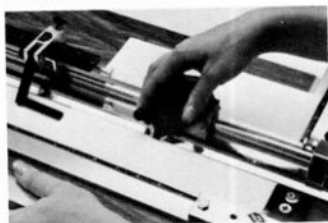

3. Reset guide and stops to 2" (50 mm). Cut opening in top mat, colored side down.

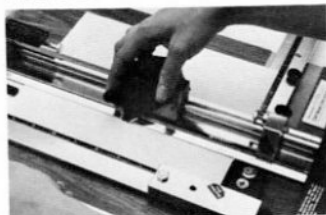

4. Reset guide and stops to 1¾" (44 mm). Cut inside bevel piece, colored side **up**.



5. Reset guide and stops to 1½" (38 mm). Cut outer opening in top mat, colored side down. Save fallout piece.

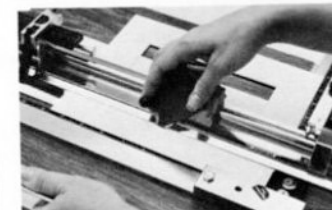

6. Remove liner from back of **outside** top mat piece.

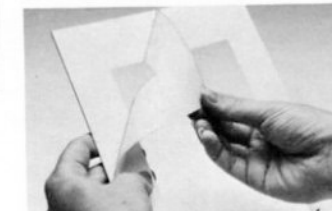

7. Position lightly onto colored side of bottom mat.

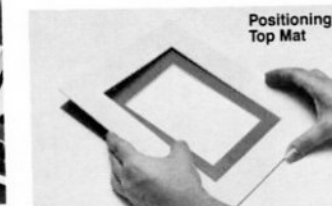

8. Remove liner from inside bevel piece and position inside opening.

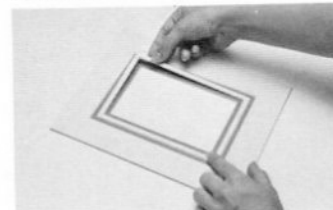

9. Use thin fallout piece as positioning aid. Roll down top mat when positioned properly.

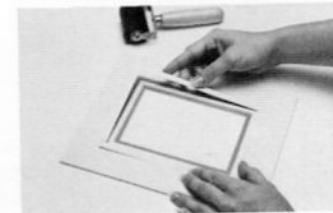

How to Cut a Slant (Photo) Corner Mat

Use C&H multi-angle plate 8.

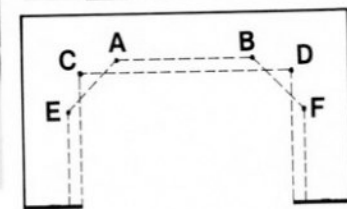
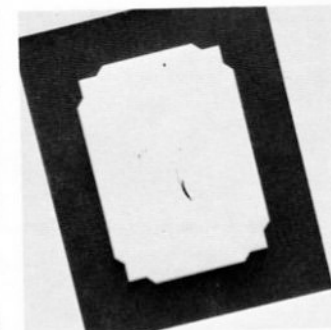

Example: 8" x 10" Mat

1. For the four long cuts, set guide at 1½" (38 mm), CH60 stops at 2¾" (70 mm) top and bottom. Cut all four sides.
2. Set guide at 3". Place 8-sided plate to read 14" (355.6 mm) on guide. Set stop D on 18" (457 mm). Set bottom stop at 12⅞" (308 mm). Cut all four sides.
3. Set guide at 1¾" (44 mm). Set stops F&E at 1¾". Cut all four sides.

Cutting Without Plates & Stops

1. Pencil in guide lines on all four sides.
2. Cut all four sides from A to B and C to D.
3. Cut 4 corners (A to E, B to F, etc.).

How to Cut 3D Double-Bevel Mats

How to Cut Slant (Photo) Corner Mats

How To Cut Fabric-Covered Board and Wrap Edges

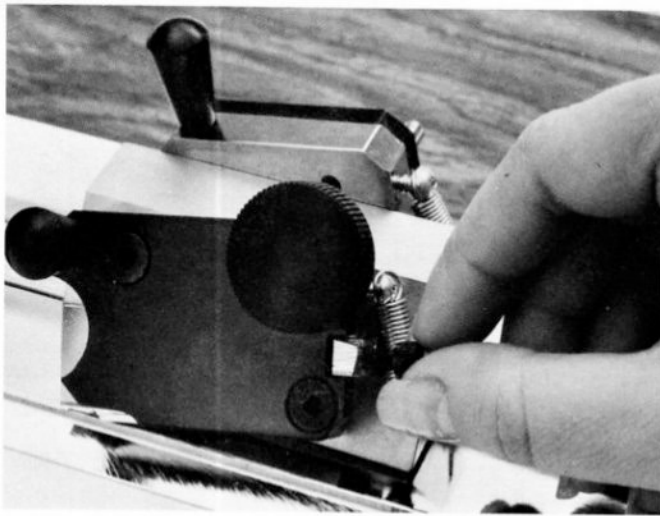

Cutting fabric-covered mats can be done with a normal bevel or you can wrap the fabric around the bevel. The latter is accomplished by cutting the mat twice, once to cut part way through and once to remove the center. After the mat board middle is removed, it leaves enough fabric to wrap around. The result — a clean professional mat with a fresh look. The method shown below works with all pre-covered fabric mat boards — linens, burlaps, silks and grasscloths.

Step 1 With some scraps of the same fabric mat you will use for framing, preset the blade so it cuts through the board but does not cut the fabric. Turn the depth screw to the left and push the blade farther back into the head. Check the cut until the proper depth is found. Place the linen fabric face down in the cutter. Make a series of cuts and be sure to press hard on the handle. Tighten the knurl screw well.

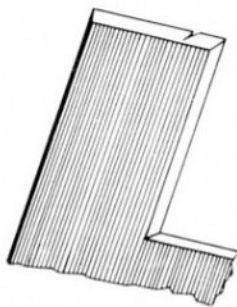

Step 2 Cut and size one 8" x 10" (203 x 254 mm) linen mat. Set guide and stops at 2" (50 mm). Cut mat. Check to make sure blade is not cutting through fabric. This cut is the opening and final mat size.

Step 3 Set the guide and stops at 3" (76 mm). Extend blade depth to cut all the way through.

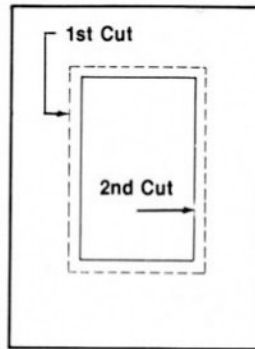

Step 4 Carefully peel the mat board edge from the fabric, then, in each corner, cut the fabric diagonally starting about 1/8" (3 mm) from the corner.

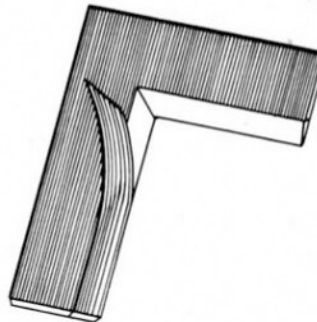

Step 5 Fold fabric around the edge of the board and adhere it to the back with glue or ATG tape.

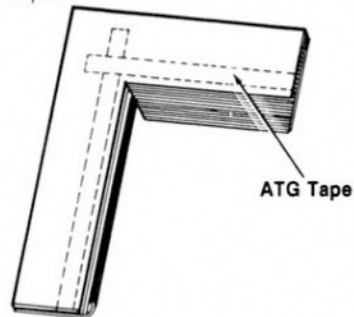

Step 6 The diagram shows the reverse side with the fabric wrapped and fastened in position. The edge is straight and smooth, just right for a professional job.

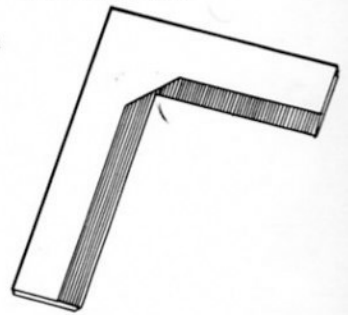

How to Cut Fabric-Covered Board and Wrap Edges

Problem	Possible Causes	Solutions
"Hooked" bevel cuts (hook at beginning and/or end of cut)	Slide block has excess wobble	Adjust block to reduce
	Blade protruding out too far from holder	Adjust blade to proper depth
	Wrong blade	Use No. 1500 blades for heavy or acid-free mat board*
	Dull or damaged blade	Replace
	"Jabbing" blade into mat board	Insert blade into board smoothly (See page 5)
Insufficient handle pressure		Hold handle in middle of mat & apply sufficient pressure to flatten out bar (See page 5)
	Large shoulder screw inside bevel blade holder loose	Tighten and/or shim under screw
Curved bevel cuts or depth of cut varies	Insufficient handle pressure	Hold handle in middle of mat & apply sufficient handle pressure to flatten out bar. Do not apply too much pressure.
	Baseboard is bowing due to warped table	Level out cutter with scrap piece(s) of matboard underneath.
	Blade not being fully depressed	Depress blade fully at beginning of cut and keep depressed during length of cutting stroke.
	Slip sheet is too narrow and/or too short or may be "ragged" from multiple cuts.	Use mat board slip sheet 6" wide x cutter capacity. Shift slip sheet on each cut and replace as it becomes ragged.
Ragged bevel cuts	Dull or damaged blade	Replace blade. See blade replacement section for proper technique to prevent damage.
	No slip sheet	Use mat board slip sheet 6" (152 mm) x capacity of cutter.
	Wrong blade	Use C&H blades only. Use #1200 blade on standard mat board and #1500 on acid-free or double-thick mat board.
	Blade hits baseboard	Hinges loose and/or out of adjustment. Loosen hinge bolts and adjust hinges so blade rides in slot.
Bevel blade cannot be secured tight	Allen screws of blade holder plate too tight	Loosen slightly
Bevel blade depth adjustment screw will not adjust blade	Burr on end of screw causing it to ride up on blade	Remove screw and file end flat
Slide block does not slide easily	Dirty block and/or rod & bar Technique	Remove, clean and lubricate Pull block straight back with finger pressure. Do not pull up with thumb under knurl screw
	Block needs adjustment	Adjust block using technique described in block adjustment section
	Nick on rod or bar	Carefully file down

*Hooked corners at the beginning of a cut and damage to the bevel as you withdraw the blade at the end of the cut may be due to a defective blade. Try a new one.

Trouble Shooting Guide

Problem	Possible Causes	Solutions
Bevel blade "overcutting"	Blade extended out too far Stops out of adjustment	Adjust blade depth Readjust
Bevel blade "undercutting"	Blade not being fully depressed at beginning of cut Stops out of adjustment	Depress blade fully Readjust
Mat width not parallel	Mat guide improperly adjusted Squaring arm on cutter Top clamping screw on mat guide not tightened Mat guide top plate may have shifted	Readjust Remove when using bevel cutter Tighten screw down on large mats Consult calibration section and readjust
V-Groove cuts not even or "ragged"	Mat guide improperly adjusted Dull blade	Readjust Replace
Mat board slipping under bar	Slip sheet too narrow Warped table Insufficient handle pressure	Use 6" (152.4 mm) wide slipsheet Level cutter with scrap board Use sufficient pressure to flatten bar
Bar & rod slides back and forth on bearing blocks	Worn hinges Missing rubber spacer inside bearing blocks	Replace hinge pins or hinges Replace
Boards not cutting square with straight side cutter	Squaring arm out of adjustment	Readjust
Difficult to cut board with straight side cutter locked down	Lock-down feature not designed for cutting all board thickness	Use lock-down feature for cutting regular thickness mat board. Do not lock down and use several cutting passes on thicker boards
Can't cut enough off of V-Groove and/or blade digs into side of baseboard	Hinges have slipped from proper position on baseboard. Usually caused by heavy abuse in shipping	Loosen recessed screws in bottom of baseboard and move hinges over so left edge of bar is at right edge of groove in baseboard. Also make sure bar is parallel to groove.

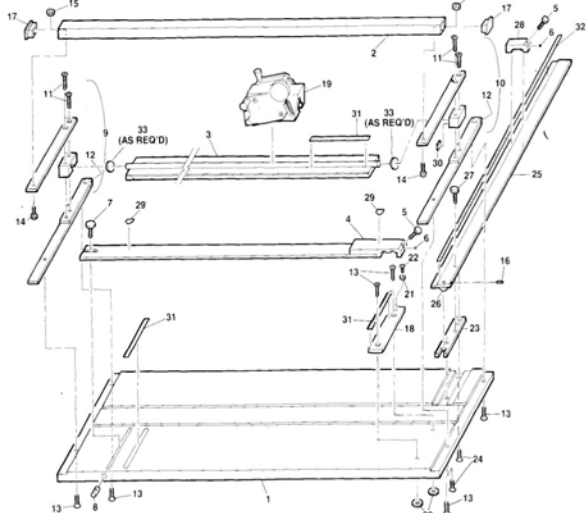

Item No.	Description	Part Number	
1.	Baseboard — 4060	78-8048-4104-3	16. Set Screw-#10-24x1/4 Lg.
	Baseboard — 4800	78-8048-4113-4	
	Baseboard — 6000	78-8048-4121-7	17. End Cap
2.	Handle — 4060	78-8048-4207-4	18. Mat Guide Top Plate
	Handle — 4800	78-8048-4208-2	19. Head Assembly (Block & Blade Holders)
	Handle — 6000	78-8048-4209-0	(See Blade Holder & Slide Block Components Under Head Assembly Illustration)
3.	Bar & Rod Assembly — 4060	78-8048-4107-6	20. T-Nut, 1/4-20
	Bar & Rod Assembly — 4800	78-8048-4116-7	21. V-Groove Cam
	Bar & Rod Assembly — 6000	78-8048-4124-1	22. Screw-Fit. Hd. Phillips #8-32x3/8 Lg.
4.	Mat Guide Assembly — 4060 & 4800	78-8048-4138-1	23. Squaring Arm Bottom Plate
	Mat Guide Assembly — 6000	78-8048-4142-3	24. Screw-Fit. Hd. Phillips 1/4-20x3/4 Lg.
5.	Knob Assembly — (5/8" Long)	78-8048-4241-3	25. Squaring Arm
6.	1/4" Dia. Steel Ball	78-8005-2700-0	26. Sq. Arm Cam Lug
7.	Knob Assembly (3/4" Long)	78-8048-4245-4	27. Knob Assembly (1/2" Long)
8.	Mat Guide Lock Nut	78-8048-4130-8	28. Squaring Arm Stop Assembly
9.	Hinge Assembly — Left	78-8048-4137-3	29. Indicator Label
10.	Hinge Assembly — Right	78-8048-4131-6	30. Burpon-Black
11.	Screw-Fit. Hd. Phillips 1/4-20x1 1/4" Lg.	26-1002-5307-4	31. Ruler-6" #R-1-E (English)
12.	Hinge Pin, Grooved 1/8" Dia. x 1" Lg. (2)	26-1003-9410-0	Ruler-16 cm #R-1-E (Metric)
13.	Screw-Fit. Hd. Phillips 1/4-20x1" Lg.	26-1002-5306-6	32. Ruler-36" #R-12-E (English)
14.	Screw-Hex Hd. 1/4-20x5/8 Lg.	26-1003-4055-8	Ruler-91.4 cm #R-12-M (Metric)
15.	Nut-Hex, Self Locking 1/4-20	26-1004-9568-3	33. Rubber Bushing-1/16" Thick
			Rubber Bushing-1/8" Thick

C&H Mat Cutters Parts List

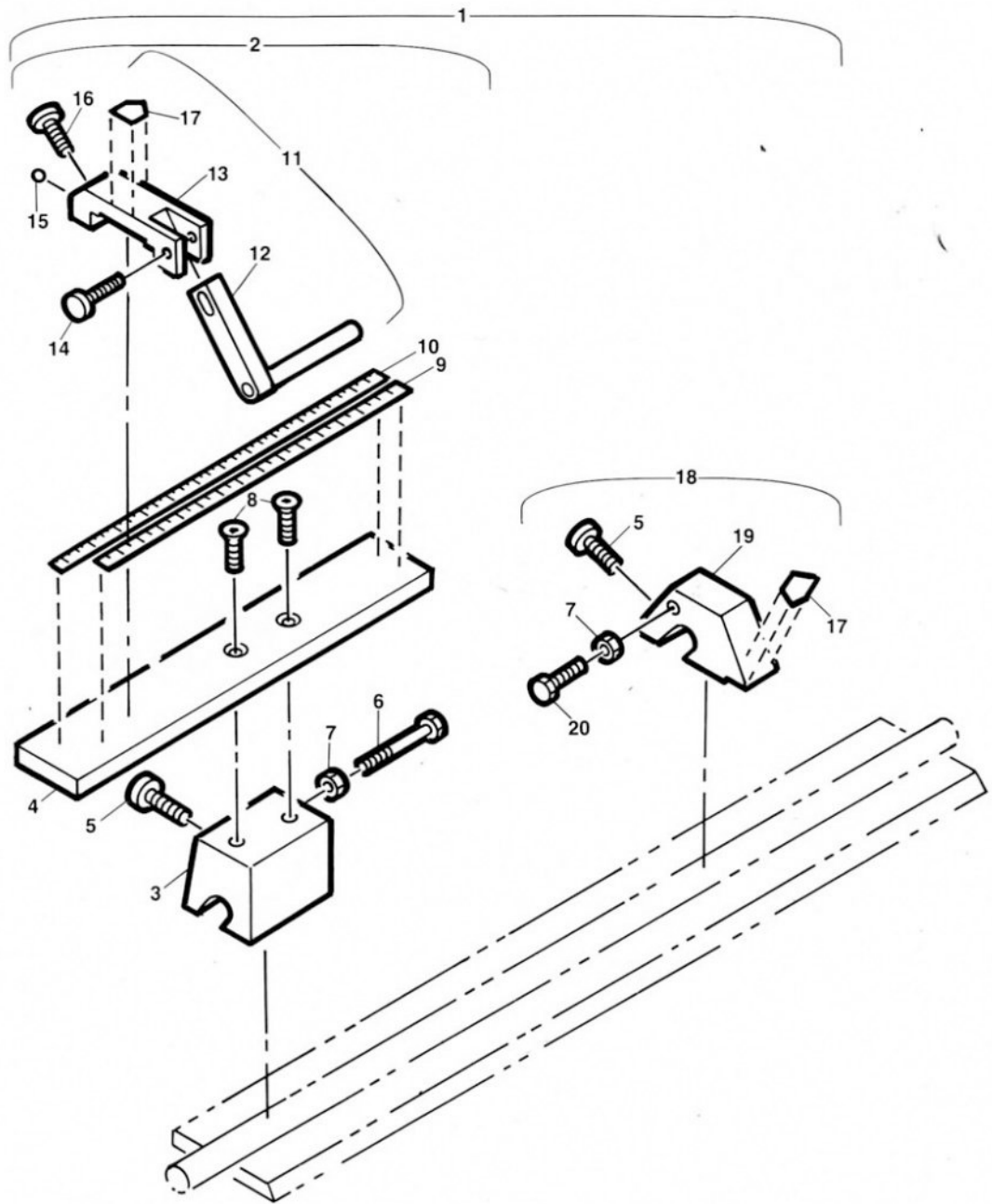

Item No.	Description	Part Number		Part Number	
1.	General Assembly — CH60	78-8048-4166-2	11.	Stop Assembly	78-8048-4170-4
2.	Upper Block Assembly	78-8048-4167-0	12.	Pivot Arm Assembly	78-8048-4173-8
3.	Upper Block	78-8048-4168-8	13.	Slide Block	78-8048-4172-0
4.	Slide Bar	78-8048-4169-6	14.	Knob Assembly (3/4" Long)	78-8048-4245-4
5.	Knob Assembly (3/4" Dia.)	78-8048-4243-9	15.	Steel Ball — 1/4" Dia.	78-8005-2700-0
6.	Screw-Cap, Hex Hd. 1/4-20x3 Lg.	12-7996-8739-2	16.	Knob Assembly (1/2" Long)	78-8048-4242-1
7.	Nut-Hex 1/4-20	12-7991-1481-9	17.	Indicator Label	78-8048-4239-7
8.	Screw-Flt. Hd. Hex Soc. #10-24x1/2 Lg.	26-1002-6777-7	18.	Lower Block Assembly	78-8048-4176-1
9.	Ruler-6" #R-1-E (English)	78-8048-4213-2	19.	Lower Block	78-8048-4177-9
10.	Ruler-16cm #R-1-M (Metric)	78-8048-4214-0	20.	Screw-Cap, Hex. Hd. 1/4-20x3/4 Lg.	12-7991-1521-2

CH60 Detachable Measuring Stops Parts List

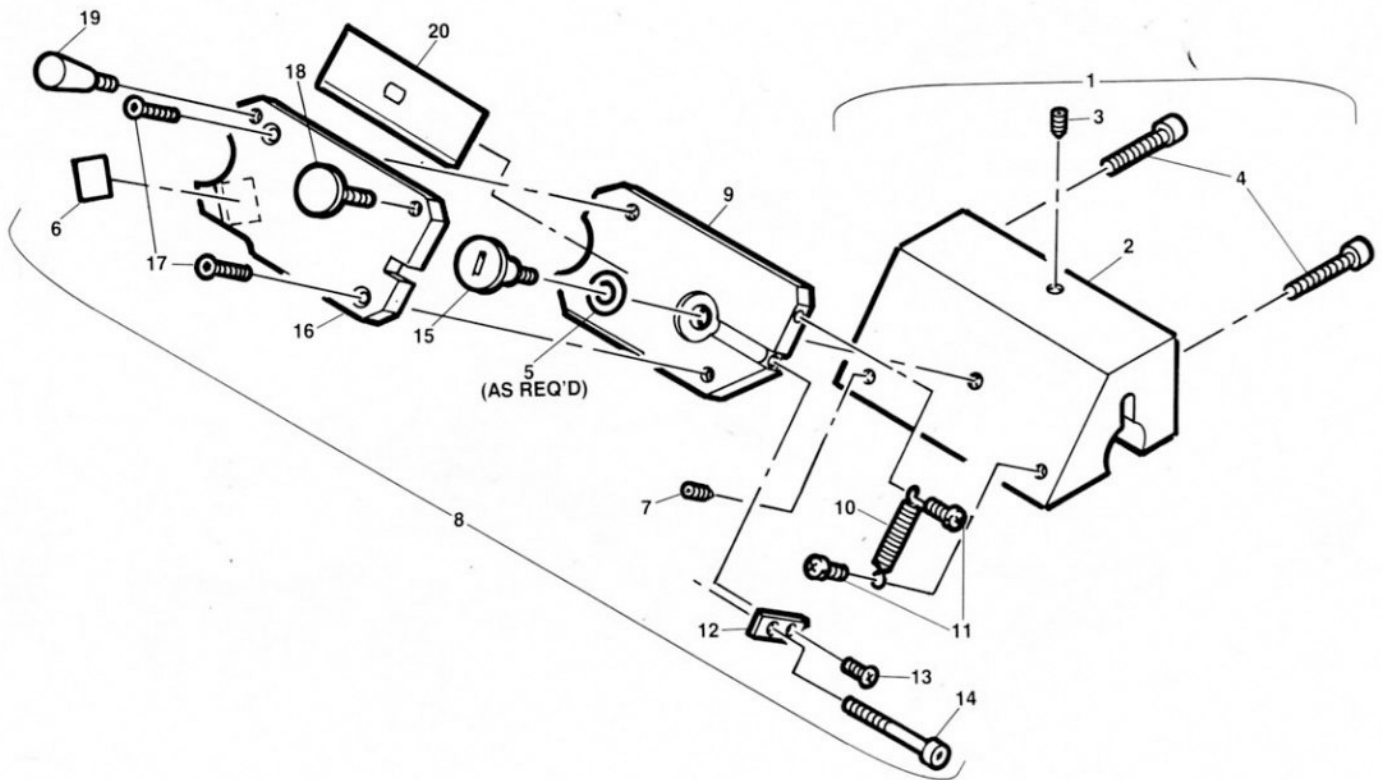

Item No.	Description	Part Number
1.	Slide Block Assembly	78-8048-4002-9
2.	Slide Block	NA
3.	Set Screw 1/4-20x1/4 Lg.	18-3414-5016-3
4.	Screw-Cap, Soc. HD. #8-32x5/8 Lg.	70-7023-3680-4
5.	Shim Kit	78-8048-4240-5
6.	Caution Decal	70-8000-4519-0
7.	Set Screw #8-32x1/4 Lg.	12-7999-5817-3
8.	Bevel Blade Holder Assembly	78-8048-4155-5
9.	Bevel Holder Bottom Plate	78-8048-4157-1
10.	Extension Spring	78-8003-7861-0
11.	Screw-Fit. Hd. Phillips #6-32x3/8 Lg.	26-1004-7285-6
12.	Depth Adjust. Plate	78-8048-4162-1
13.	Screw-Fit. Hd. Phillips #6-32x3/8 Lg.	26-1002-5310-8
14.	Screw-Cap, Hex. Soc. Hd. #8-32x1" Lg.	18-3172-9215-1
15.	Shoulder Screw	78-8048-4158-9
16.	Bevel Holder Top Plate	78-8048-4159-7
17.	Screw-Fit. Hd. Hex. Soc. #10-24x1/2 Lg.	26-1002-6777-7
18.	Knob Assembly (1" Dia.)	78-8048-4244-7
19.	Knob Assembly	78-8044-0377-8
20.	C&H Blade #1200 (Box of 100)	70-0700-6176-0
	C&H Blade #1500 (Box of 100)	70-0700-6177-8

C&H Head Assembly Parts List

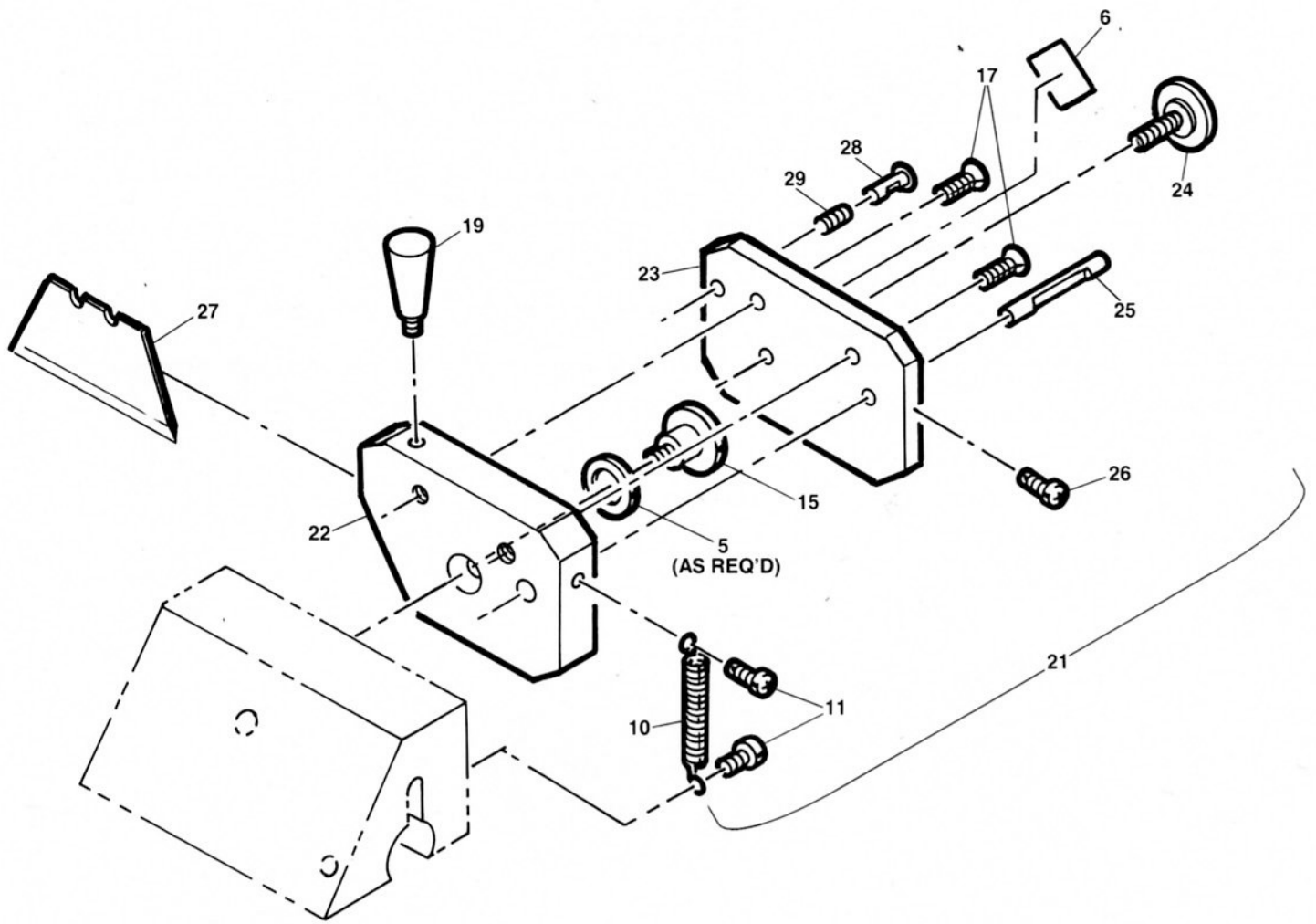

Item No.	Description	Part Number	Part Number
21.	Back Blade Holder Assembly	78-8048-4003-7	26. Screw-Rnd. Hd. Phillips #6-32x1/4 Lg. 26-1001-9402-1
22.	Bottom Plate	78-8044-0385-1	27. Blade (Stanley #1991 Type) 26-1004-9917-2
23.	Top Plate	78-8044-0387-7	28. Safety Button 78-8048-4000-3
24.	Knob Assembly (3/8 Long)	78-8044-0589-8	29. Compression Spring 78-8003-7897-4
25.	Lock Pin	78-8044-0388-5	

C & H Mat Cutter Operating Manual & Parts List

Several major components of the C & H Mat Cutters have been modified and improved. This information sheet is intended to point out these changes, properly describe them and specify any instructional changes in this manual.

CHANGE NO. 1

Page 2, Description of Cutter Parts; No. 1, Bar & Rod Assembly should read:

Bar/Rod—This component has a hard finish and a self-lubricating coating. The bar/rod has a deliberate bow which creates a uniform clamping force when handle pressure is applied. The bar/rod also provides a precision tracking surface for the sliding block.

Call-out should also read—1-bar/rod

CHANGE NO. 2

Page 2, Description of Cutter Parts, No. 4, Bevel Blade Holder should read:

An adjustable, precision metal alloy assembly. Mounts and pivots on the bevel side of the sliding block. Designed for C & H No. 1200 and No. 1500 blades.

CHANGE NO. 3

Page 3, Description of Cutter Parts, No. 15, Straight Side Blade Holder should read:

Straight Side Blade Holder—An adjustable, precision metal alloy assembly. Mounts and pivots on the right side of the sliding block. Designed for Stanley No. 1991 blade or equivalent.

CHANGE NO. 4

Page 4, Setting Blade Depth (Bevel Cutter), should read:

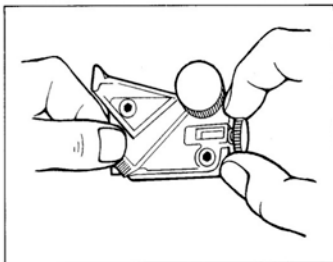

The blade should project from the blade holder so that it cuts through the mat board and just slightly scores the underlying slip sheet. Test this out with two scrap pieces of mat board. **NOTE:** If the blade is out too far, it may bend and cause hooked corners. To adjust the blade depth, loosen the large blade holder knob. While holding and pushing in slightly on the front of the blade, turn the blade adjustment thumb screw counter-clockwise to **increase** the blade depth and clockwise to **reduce** the blade depth.

CHANGE NO. 4
(Continued)

Page 4, Setting Blade Depth (Bevel Cutter) should read:

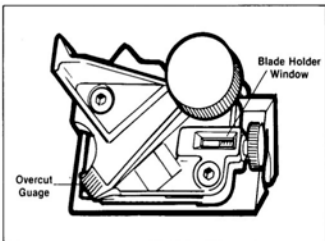

Retighten the blade holder knob. The graduations on the blade holder window can be used as a reference for blade depth. The large increments are $\frac{1}{16}$ " (1.59mm) and the small are $\frac{1}{32}$ " (0.79mm). The graduations on the bottom corner of the blade holder are in the same increments and can be used as a visual gauge for over- or under-cuts.

CHANGE NO. 5

Page 5, Holding the Cutter should read:

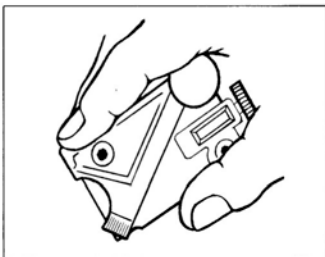

Stand at the end of the cutter with your shoulder lined up with the bar/rod. Make sure you pull the cutter block straight back without bending the elbow sideways. Lift the handle and insert the mat board under the bar/rod. The recommended position for the hand is to place the index and middle fingers on the top side of the blade holder handle. The thumb can be placed under the blade holder as shown for extra leverage. Insert the blade into the board by pushing down with the two fingers until the blade stops. Don't jab the blade in. Then pull back keeping the blade holder fully depressed over the entire length of the cut.

CHANGE NO. 6

Page 16, C & H Mat Cutters Parts List should read:

ITEM NO.	DESCRIPTION	PART NUMBER
3	Bar/Rod—4060	78-8052-8901-0
	Bar/Rod—4800	78-8052-8902-8
	Bar/Rod—6000	78-8052-8903-6
19	No Change	78-8052-8893-9

CHANGE NO. 7

Page 18, C & H Head Assembly Parts List (Bevel Blade Holder). All new parts—refer to revised Page No. 18, attached, for new illustrations and parts.

CHANGE NO. 8

Page 19, C & H Head Assembly Parts List (Back Blade Holder). All new parts—refer to revised Page No. 19, attached, for new illustrations and parts.

C&H Mat Cutters Parts List

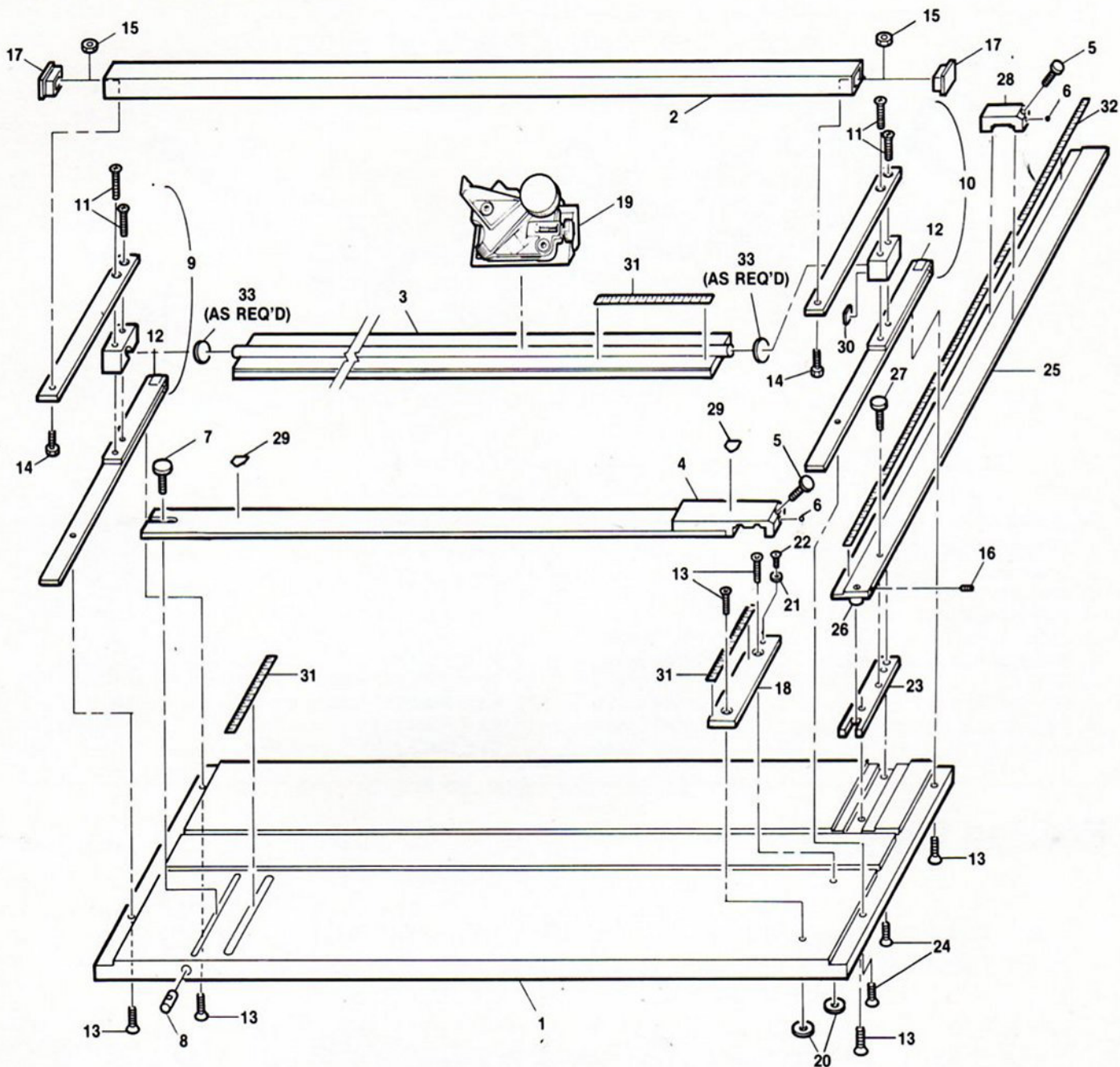

Item No.	Description	Part Number
1.	Baseboard—4060	78-8048-4104-3
	Baseboard—4800	78-8048-4113-4
	Baseboard—6000	78-8048-4121-7
2.	Handle—4060	78-8048-4207-4
	Handle—4800	78-8048-4208-2
	Handle—6000	78-8048-4209-0
3.	Bar/Rod—4060	78-8052-8901-0
	Bar/Rod—4800	78-8052-8902-8
	Bar/Rod—6000	78-8052-8903-6
4.	Mat Guide Assembly—4060 & 4800	78-8048-4138-1
	Mat Guide Assembly—6000	78-8048-4142-3
5.	Knob Assembly—(1/8" Long)	78-8048-4241-3
6.	1/4" Dia. Steel Ball	78-8005-2700-0
7.	Knob Assembly (3/4" Long)	78-8048-4245-4
8.	Mat Guide Lock Nut	78-8048-4130-8
9.	Hinge Assembly—Left	78-8048-4137-3
10.	Hinge Assembly—Right	78-8048-4131-6
11.	Screw-Flt. Hd. Phillips 1/4-20x1 1/4" Lg.	26-1002-5307-4
12.	Hinge Pin, Grooved 1/8" Dia. x 1" Lg. (2)	26-1003-9410-0
13.	Screw-Flt. Hd. Phillips 1/4-20x1" Lg	26-1002-5306-6
14.	Screw-Hex Hd. 1/4-20x3/8" Lg	26-1003-4055-8
15.	Nut-Hex, Self Locking 1/4-20	26-1004-9568-3

Item No.	Description	Part Number
16.	Set Screw-#10-24x 1/4 Lg.	12-7997-0576-4
17.	End Cap	26-1004-9744-0
18.	Mat Guide Top Plate	78-8048-4128-2
19.	Head Assembly (Block & Blade Holders). 78-8052-8893-9 (See Blade Holder & Slide Block Components Under Head Assembly Illustration)	78-8052-8893-9
20.	T-Nut, 1/4-20	78-8654-7120-1
21.	V-Groove Cam	78-8048-4129-0
22.	Screw-Flt. Hd. Phillips #8-32x3/8" Lg.	26-1002-5317-3
23.	Squaring Arm Bottom Plate	78-8048-4127-4
24.	Screw-Flt. Hd. Phillips 1/4-20x3/4 Lg.	26-1002-5359-5
25.	Squaring Arm	78-8048-4145-6
26.	Sq. Arm Cam Lug	78-8048-4146-4
27.	Knob Assembly (1/2" Long)	78-8048-4242-1
28.	Squaring Arm Stop Assembly	78-8048-4160-5
29.	Indicator Label	78-8048-4239-7
30.	Bumpon-Black	26-1002-3325-8
31.	Ruler-6" #R-1-E (English)	78-8048-4213-2
	Ruler-16 cm #R-1-E (Metric)	78-8048-4214-0
32.	Ruler-36" #R-12-E (English)	78-8048-4215-7
	Ruler-91.4 cm #R-12-M (Metric)	78-8048-4216-5
33.	Rubber Bushing-1/16" Thick	78-8048-4212-4
	Rubber Bushing-1/8" Thick	78-8048-4165-4

Revised Page 18

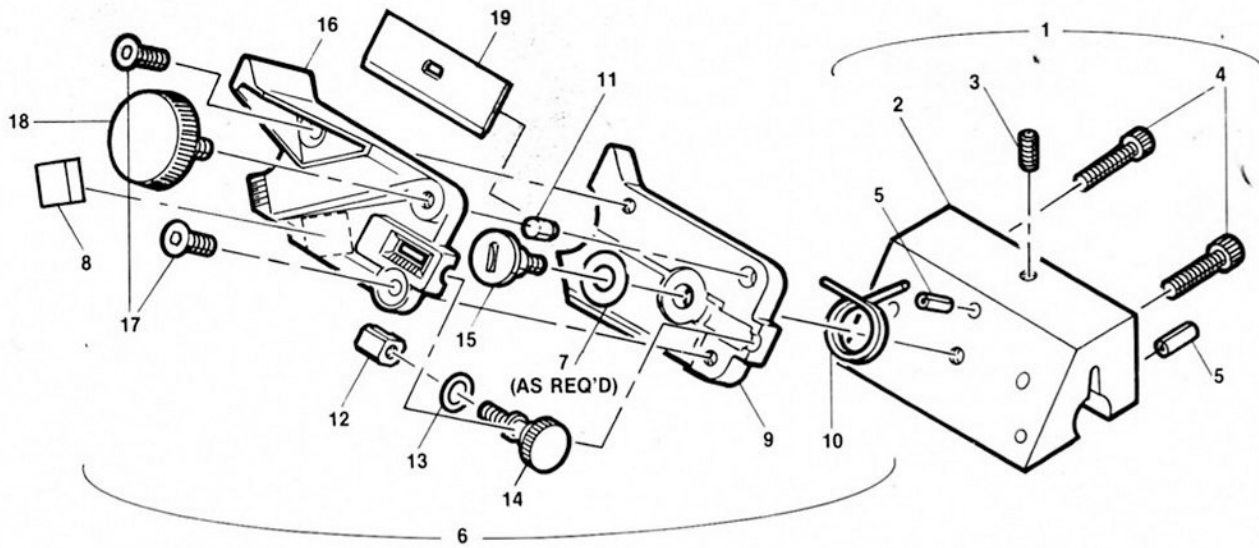

Item No.	Description	Part Number
1.	Slide Block Ass'y	78-8052-8892-1
2.	Slide Block	N/A
3.	Set Screw 1/4-20x 1/4 Lg.	18-3414-5016-3
4.	Screw-Cap Soc. Hd. #8-32x 3/8 Lg.	70-7023-3680-4
5.	Spring Pin 1/2 Dia. x 7/16 Lg.	26-1000-2720-5
6.	Bevel Blade Holder Assembly	78-8052-8891-3
7.	Shim Kit	78-8048-4240-5
8.	Caution Decal	70-8000-4519-0
9.	Bevel Holder Bottom Plate	78-8052-8850-9
10.	Torsion Spring	78-8052-8879-8

Item No.	Description	Part Number
11.	Dowel Pin 3/16 Dia. x 1/4 Lg.	12-7996-6730-3
12.	Nut-Blade Adjust.	78-8052-8874-9
13.	O-Ring 1/4 I.D.	12-7995-5848-6
14.	Thumb Screen-Blade Adjust.	78-8052-8875-6
15.	Shoulder Screw	78-8048-4158-9
16.	Bevel Holder Top Plate	78-8052-8861-6
17.	Screen-Fit. Hd. Hex. Soc. #10-24 x 1/2 Lg.	26-1002-6777-7
18.	Knob Assembly (3/4" Dia. x 1/2" Lg.)	78-8052-8789-9
19.	C&H Blade #1200 (Box of 100)	70-0700-6176-0
	C&H Blade #1500 (Box of 100)	70-0700-6177-8

Revised Page 19

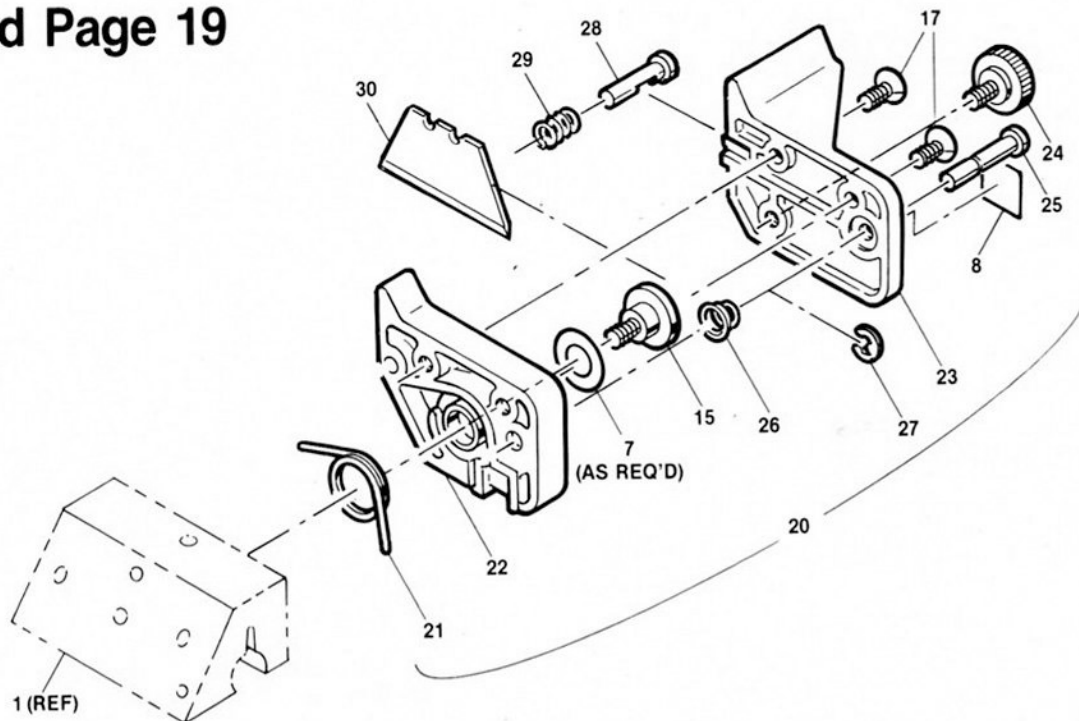

Item No.	Description	Part Number
20.	Back Blade Holder Assembly	78-8052-8899-6
21.	Torsion Spring	78-8052-8880-6
22.	Bottom Plate	78-8052-8867-3
23.	Top Plate	78-8052-8868-1
24.	Knob Assembly (3/8 Lg)	78-8044-0589-8
25.	Lock Pin	78-8052-8873-1

Item No.	Description	Part Number
26.	Conical Spring	78-8052-8894-7
27.	Retaining Ring .145 I.D.	78-8656-4001-1
28.	Safety Button	78-8048-4000-3
29.	Compression Spring	78-8003-7897-4
30.	Blade (Stanley #1991 Type)	26-1004-9917-2