

# *Onyx 90 Media Cutter*

## *Parts Manual*



*Professional Picture Frame Equipment  
441 South Whitted Street  
Hendersonville, NC 28739*

*The World's Best Media Cutter*

## **Thank you for purchasing the Onyx 90 Media Cutter.**

The following parts manual gives you a complete breakdown of all replaceable parts for the Onyx 90.

To order a part for your Onyx 90 please review this manual, make note of the listed page and part number and call our Office at 1-828-707-5848 to talk with a Sales associate who will gladly assist you with placing your order.

# Onyx 90 Media Cutter

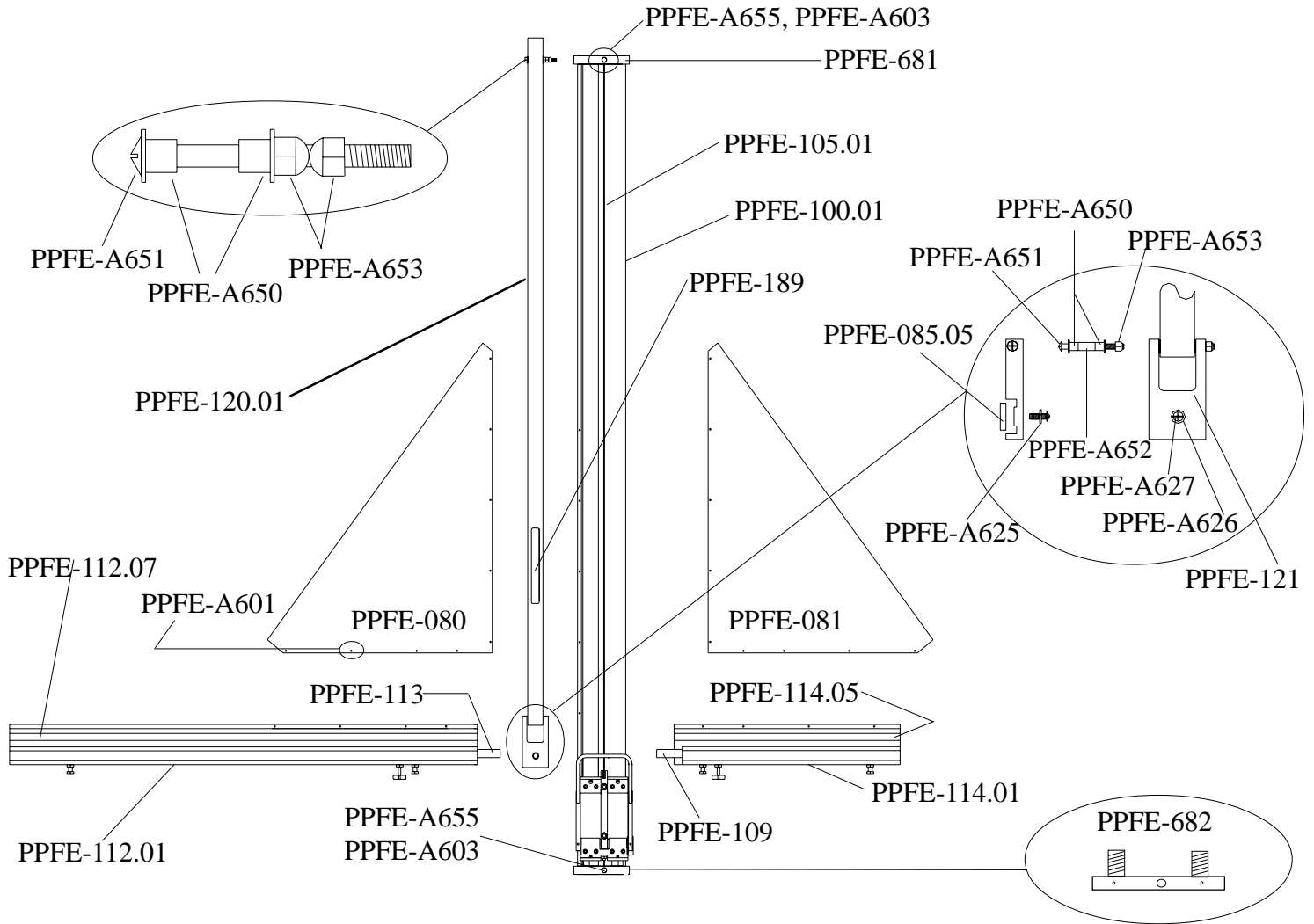

Front Main View		
PART #	DESCRIPTION	QTY
PPFE-080	Left SS Gusset	1
PPFE-081	Right SS Gusset	1
PPFE-085.05	T-Nut	1
PPFE-100.01	Vertical Extrusion	1
PPFE-105.01	Vert.-L to R. Scale 50"	1
PPFE-109	Right Side Cutting Bed	1
PPFE-112.01	Left Horizontal Extrusion	1
PPFE-112.07	Horiz-R to L Scale 50"	1
PPFE-113	Left Side Cutting Bed	1
PPFE-114.01	Right Horizontal Extrusion	1
PPFE-114.05	Horiz-L to R. Scale 50"	1
PPFE-120.01	Media Clamp Tube	1
PPFE-121	Lower Media Clamp Bracket	1

Front Main View		
PART #	DESCRIPTION	QTY
PPFE-189	Media Clamp Handle	1
PPFE-681	Bearing Tube Strap Clamp-Top	1
PPFE-682	Bearing Tube Strap Clamp With Springs-Bottom	1
PPFE-A601	4/40 x 3/8" Machine Screw	18
PPFE-A603	7/8" Flat Washer	2
PPFE-A625	1/4" Flat Washer	1
PPFE-A626	Ext. tooth lock washers 1/4	1
PPFE-A627	1/4-20 x 3/4" CRMS Fastener	1
PPFE-A650	Brz. Flanged Bearing 1/4" x 3/8"	4
PPFE-A651	1/4-20 X 2 3/4" CRMS fastener	2
PPFE-A652	Vinyl Tubing	1
PPFE-A653	Nylock Nut 1/4-20	3
PPFE-A655	5/16-18 x 2 3/4 Hex Cap Screw	2

# Onyx 90 Media Cutter

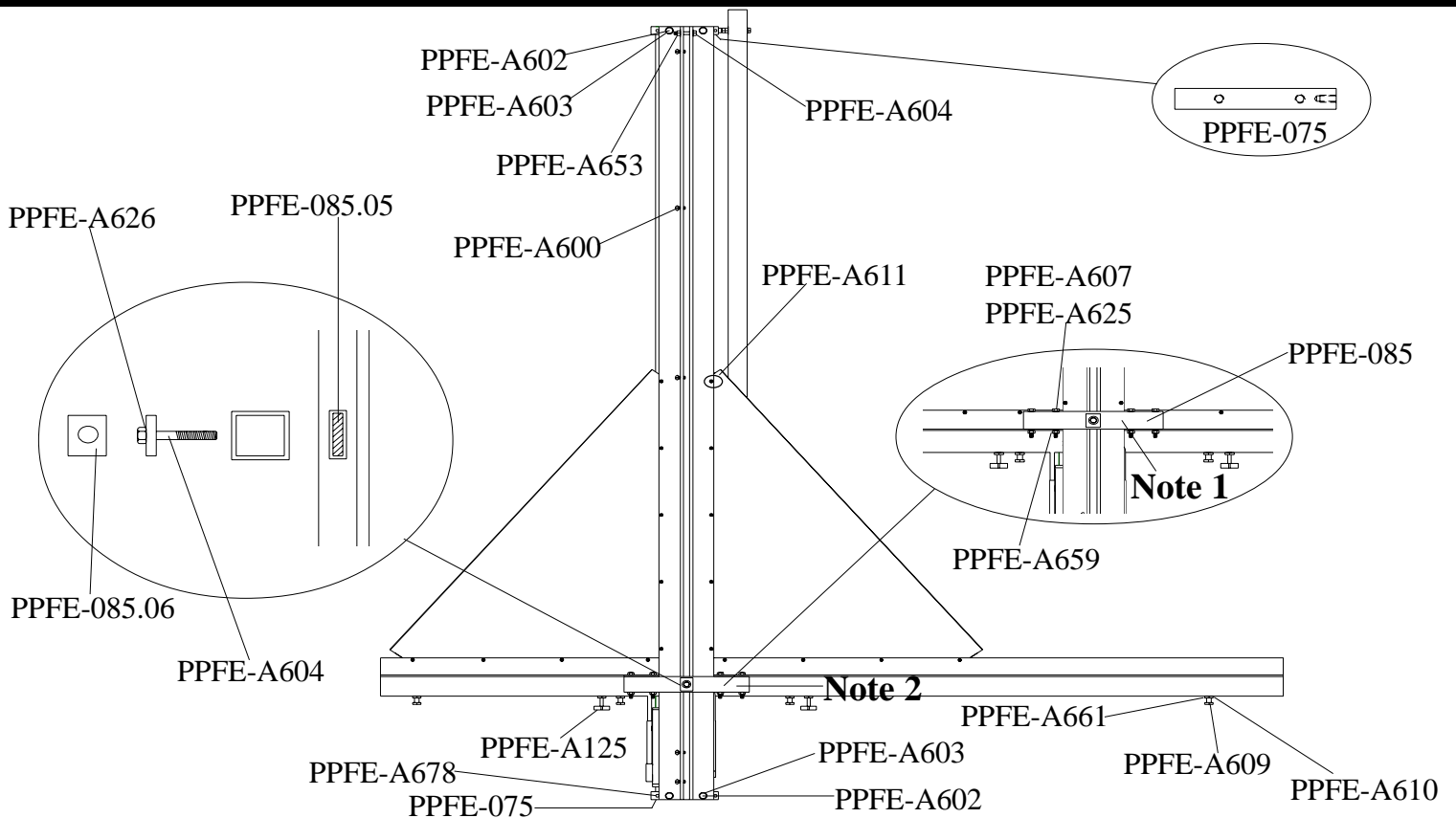

## Rear Main View

PART #	DESCRIPTION	QTY
PPFE-075	Cart Bearing Tubes Mounting Brackets	2
PPFE-085	Horizontal Tube Mounting Bracket	1
PPFE-085.05	T-Nut	1
PPFE-085.06	T-Nut Washer	1
PPFE-A125	Star shaped knob	2
PPFE-A600	CRMS Fastener 1/4-20 x 1"	5
PPFE-A602	Bearing Tube & Mounting Bracket fasteners 5/16-18 x 3/4"	4
PPFE-A603	7/8" Flat Washer	4
PPFE-A604	1/4-20 X 1 1/2" Hex Cap Bolt (Safety)	1
PPFE-A607	Extrusion Attaching bolts 1/4-20 x 2"	4
PPFE-A609	Hex Head Screw 3/8-16 x 1 1/2"	4
PPFE-A610	3/8-16 Jam Nut	4
PPFE-A611	4/40 Nylock Nut	18
PPFE-A625	1/4" Flat Washer	4
PPFE-A626	External Tooth Lock Washer	1
PPFE-A653	1/4-20 Nylock Nut (Safety)	1
PPFE-A659	1/4-20 Jam Nut	4
PPFE-A661	3/8-16 Slab Weld Nut	4
PPFE-A678	1/4 X 3/4 Steel Slotted Spring Pin	4

### Note 1

Serial # 100107 to 113707  
Horizontal tube mounting bracket is above ridge line of the horizontal extrusion.

### Note 2

Serial # 113807 and above  
Horizontal tube mounting bracket is below ridge line of the horizontal extrusion.

# Onyx 90 Media Cutter

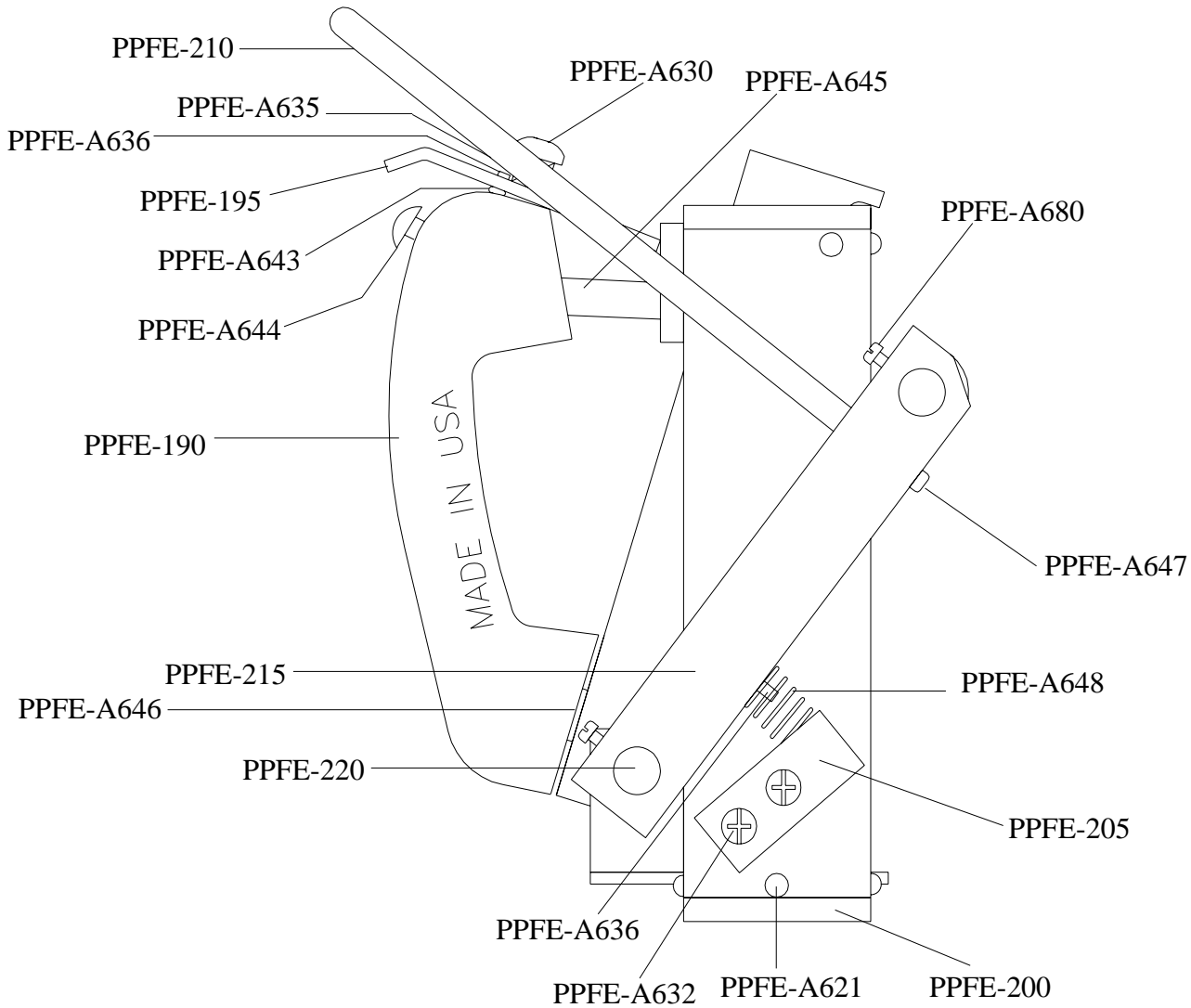

Cart Assembly - Side View		
PART #	DESCRIPTION	QTY
PPFE-190	Cart Handle	1
PPFE-195	Stop Finger	1
PPFE-200	Cart Bearings	4
PPFE-205	Acrylic spring retainer	1
PPFE-210	Acrylic Cracker Handle	1
PPFE-215	Acrylic Roller Lever	2
PPFE-220	Main Cart Axials	2
PPFE-A621	Drive Screw #6 & lockwasher	12
PPFE-A630	Pan Head Screw 10-24 X 5/8	1
PPFE-A632	CRMS Fastener 1/4-20 x 1/2	2

Cart Assembly - Side View, Cont.		
PART #	DESCRIPTION	QTY
PPFE-A635	Compression Spring 1/2"	1
PPFE-A636	Spring retainer pin 1/8 x 5/8	1
PPFE-A643	O-Ring 1/4 x 3/8	1
PPFE-A644	Jam Nut 3/8-16 x 1	1
PPFE-A645	Vinyl Tubing - Cart Handle	1
PPFE-A646	O-Ring 3/8 x 9/16	1
PPFE-A647	Pan Head Screw 8/32 x 3/4	2
PPFE-A648	Compression Spring 1 1/2"	1
PPFE-A680	Pan Head Screws 8-32x3/8	4

# Onyx 90 Media Cutter

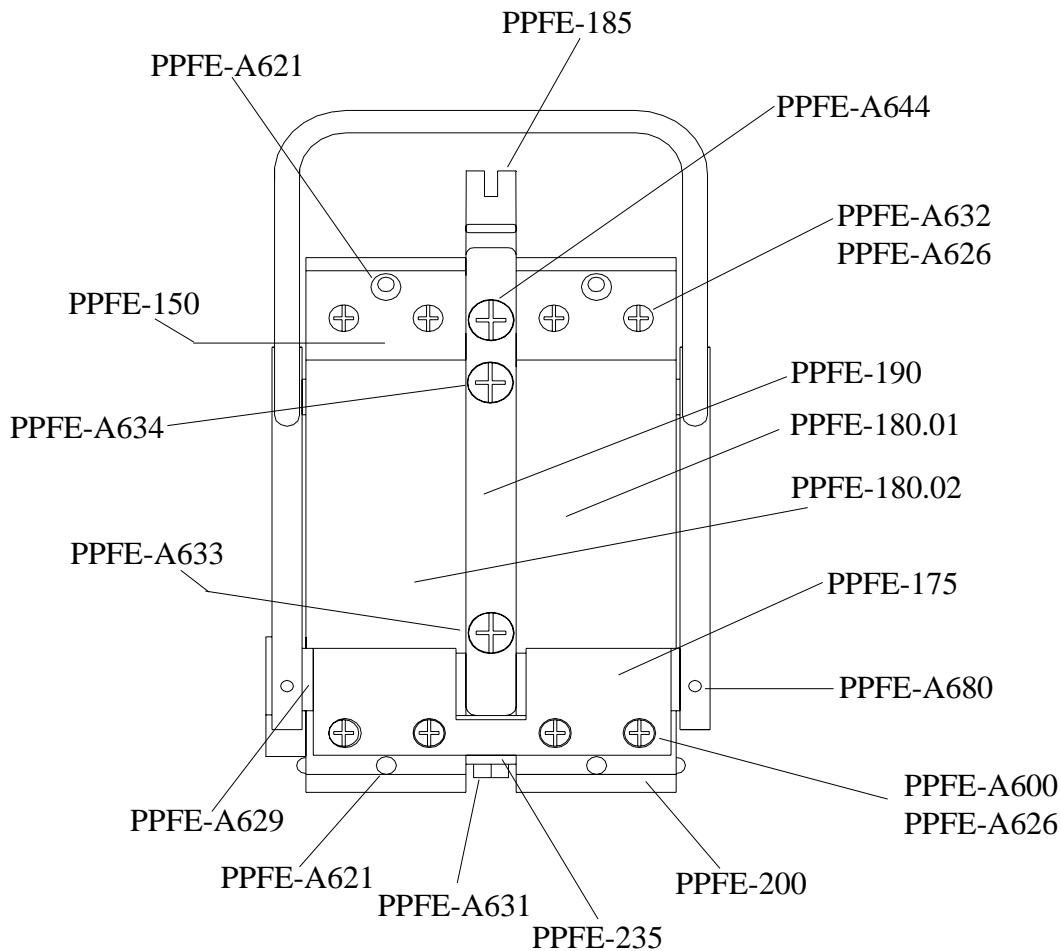

**Cart Assembly - Front View**

PART #	DESCRIPTION	QTY
PPFE-150	Steel Stop Plate	1
PPFE-175	Pivot Block Housing	1
PPFE-180.01	Cart Bearing tube right	1
PPFE-180.02	Cart Bearing tube left	1
PPFE-185	Main Pivot Swing Arm	1
PPFE-190	Cart Handle	1
PPFE-200	Cart Bearings	4
PPFE-235	Spring Anchor Bracket	1
PPFE-A600	CRMS Fastener 1/4-20 x 1	4

**Cart Assembly - Front View**

PART #	DESCRIPTION	QTY
PPFE-A621	Drive Screw Nail #6 x 1/4	12
PPFE-A626	External tooth lock washers 1/4	8
PPFE-A629	Brz flanged bearings 1/2 x 5/8	4
PPFE-A631	Self Tapping Screw 10-24 x 5/8	2
PPFE-A632	CRMS Fastener 1/4-20 x 1/2	4
PPFE-A633	CRMS Fastener 3/8-16 x 1 1/2	1
PPFE-A634	Depth Adj. Screw 3/8-16 x 3	1
PPFE-A644	Jam Screw 3/8-16 x 1	1
PPFE-A680	Pan Head Screws 8-32x3/8	4

# Onyx 90 Media Cutter

## Cart Assembly - Rear View

PART #	DESCRIPTION	QTY
PPFE-222.01	Acrylic Rollers Narrow	2
PPFE-222.02	Acrylic Rollers Wide	2
PPFE-222.03	Acrylic Rollers Beveled	1
PPFE-235	Spring Anchor Bracket	1
PPFE-A621	Easy Drive Screw Nail	12
PPFE-A638	1/4-20x 1" Slotted Pan	1
PPFE-A639	Spade Head Thumb Screw	1
PPFE-A641	Shaft Lock Collars	2
PPFE-A642	Extension Spring 2-1/2"	1
PPFE-A647	Pan Head Screw 8/32 x 3/4	2
PPFE-A648	Compression Spring 1-1/2"	1
PPFE-A653	Nylock Nut 1/4-20	2

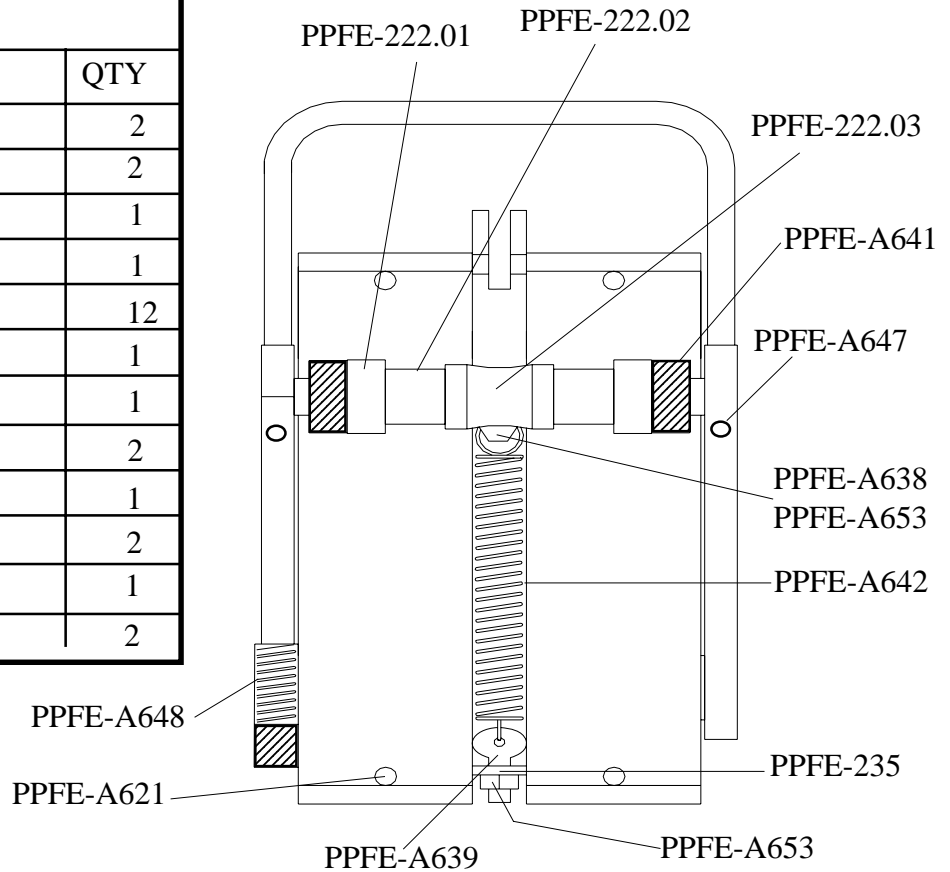

PPFE-A690

Cart Assembly - Top View		
PART #	DESCRIPTION	QTY
PPFE-A690	1/4-20 Slab Nut	10

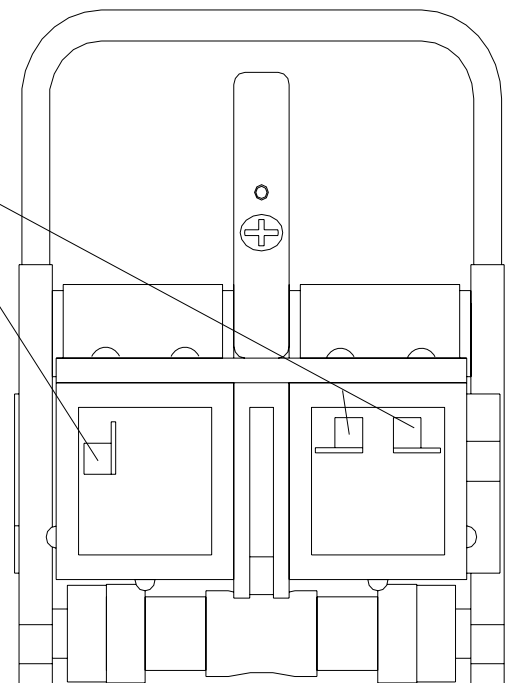

# Onyx 90 Media Cutter

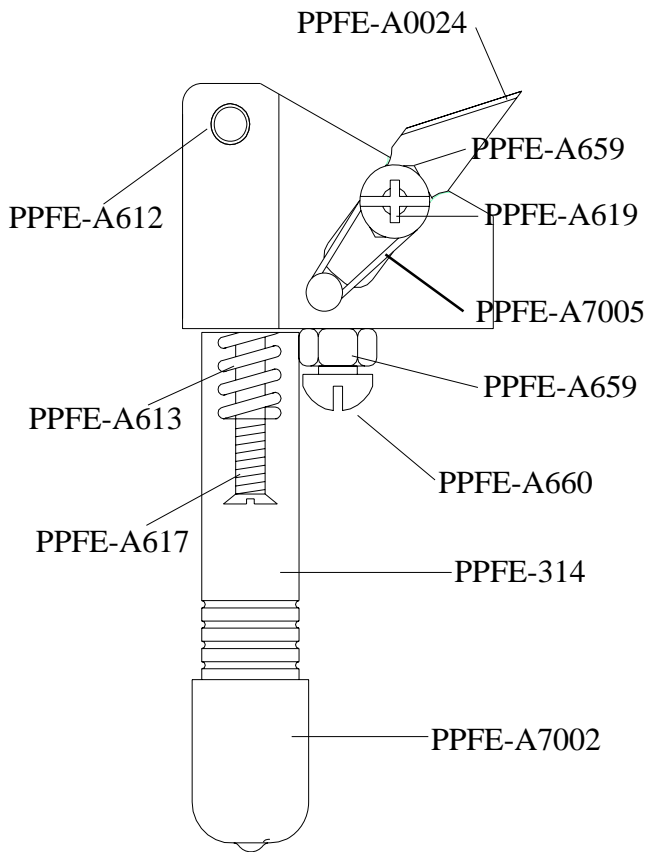

Mat Cutting Tool Holder (Blade sold separately)		
PART #	DESCRIPTION	QTY
PPFE-0024A	Mat Cutting Blades (100/pk)	1
PPFE-305	Mat Cutting Tool Holder	1
PPFE-314	Handle	1
PPFE-A612	Steel Slotted Spring Pin 1/4 x 1/2	1
PPFE-A613	1 1/4" Compression Spring	1
PPFE-A7002	Rubber Grip Black	1
PPFE-A617	10/24 x 1 3/4 Flat Head Screw	1
PPFE-A619	1/4-20 x 3/8 Slotted Screw	1
PPFE-A659	1/4-20 Jam Nut	1
PPFE-A660	1/4-20 x 5/8 Slotted Screw	1
PPFE-A7005	Rubber O ring	1

Glass Cutting Tool Holder (Turret sold separately)		
PART #	DESCRIPTION	QTY
PPFE-302	Glass Cutting Tool Holder	1
PPFE-314	Handle	1
PPFE-A612	Steel Slotted Spring Pin 1/4 x 1/2	1
PPFE-A613	1 1/4" Compression Spring	1
PPFE-A7003	Rubber Grip Red	1
PPFE-A617	10/24 x 1 3/4 Flat Head Screw	1
PPFE-A618	12mm Metric Machine Screw	1
PPFE-A7001	Glass Turret (6 carbide wheels)	1

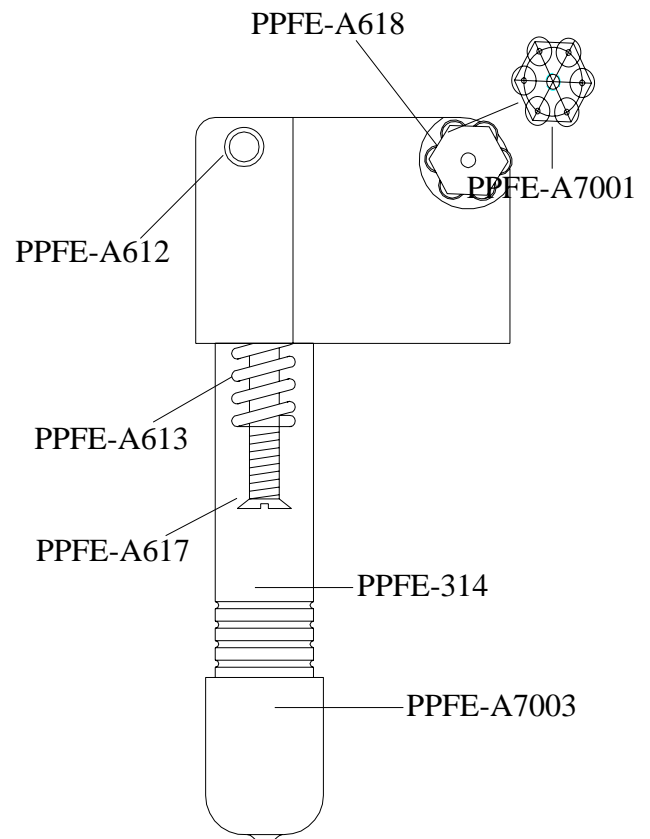



# Onyx 90 Media Cutter

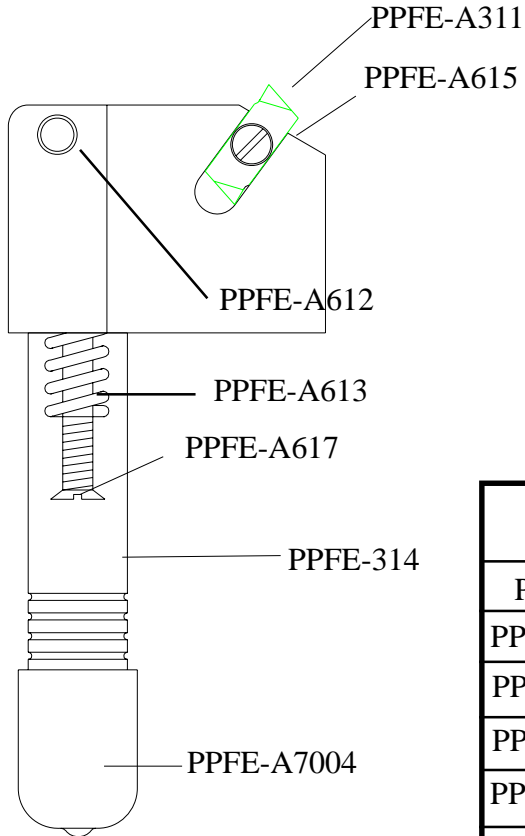

Acrylic Cutting Tool Holder (Carbide Cutter sold separately)		
PART #	DESCRIPTION	QTY
PPFE-310	Acrylic Tool Holder	1
PPFE-314	Handle Assembly	1
PPFE-A311	Carbide Cutter (2 ended)	1
PPFE-A612	Steel Slotted Spring Pin 1/4 x 1/2	1
PPFE-A613	1 1/4" Compression Spring	1
PPFE-A615	Blade Retainer Screw 6-32x1/4	1
PPFE-A7004	Rubber Grip Blue	1
PPFE-A617	10/24 x 1 3/4 Flat Head Screw	1

# Onyx 90 Media Cutter

Mounting Brackets		
PART #	DESCRIPTION	Qty
PPFE-500.01	Top Mounting Bracket	1
PPFE-500.02	Bottom Mounting Bracket	1
PPFE-500.03	Left or Right Mounting Bracket	2
PPFE-010.1	"Professional PPF" Vinyl letters	1
PPFE-010.2	"Onyx 90" Vinyl letters	1

## Vinyl letters

Professional Picture Frame Equipment

Onyx 90

PPFE-010.2

PPFE-010.1

PPFE-500.03

PPFE-500.02

PPFE-500.01

PPFE-500.03

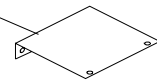
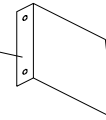
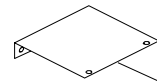
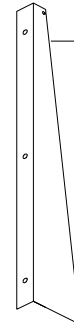

Production Stop		
PART #	DESCRIPTION	Qty
PPFE-050	Production Stop Assembly	1
PPFE-050.03	Stop Finger	1
PPFE-085.05	T-Nut	1
PPFE-A125	Star Shaped Nylon Knob	1
PPFE-A653	1/4-20 Nylock Nut	1
PPFE-A666	1/4-20x 2 1/4" Flat Head Screw	1

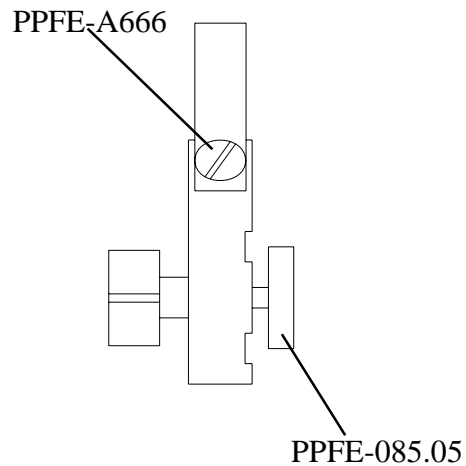
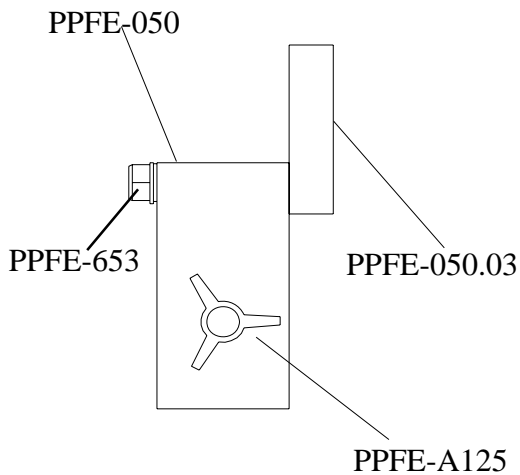

# Onyx 90 Media Cutter

## Boxes Included with Onyx 90

<b>Hardware Box</b>		
<b>4 Parts Bags included in each box</b>		
<b>PART #</b>	<b>DESCRIPTION</b>	<b>Qty</b>
PPFE-A637	Wall Mount Hardware Box (Complete)	1
PPFE-A663	13/32" Flat Washer - Bag #1	10
PPFE-A664	Screw Anchors - Bag #1	10
PPFE-A665	# 10 x 1" Pan Head - Bag #1	10
PPFE-A607	1/4-20 x 2" CRMS Fastener - Bag #2	4
PPFE-A625	1/4 Flat Washer - Bag #2	8
PPFE-A632	1/4-20 x 1/2" CRMS Fastener - Bag #2	4
PPFE-A653	1/4-20 Nylock Nut - Bag #2	8
PPFE-A601	4/40 x 3/8" Machine Screw- Bag #3	20
PPFE-A611	4/40" Nylock Nut - Bag #3	20
PPFE-A602	5/16-18 x 3/4" Hex Cap Screw - Bag #4	4
PPFE-A603	5/16-18 Flat Washer - Bag #4	4

<b>Tooling Package Box</b>		
<b>PART #</b>	<b>DESCRIPTION</b>	<b>Qty</b>
PPFE-305	Mat Cutting Tool Holder	1
PPFE-302	Glass Cutting Tool Holder	1
PPFE-310	Acrylic Cutting Tool Holder	1
PPFE-0024	Spare Blades for Mat Cutter	1
PPFE-A662	1/4" Allen Wrench for Mat Cutter	1